

iPro™ SLA® Center

User's Manual

iPro™ 8000 SLA® Center

iPro™ 9000 SLA® Center

Redefining **High** Definition



225907-00 Revision B

Copyright © 2008-2009 by 3D Systems Corporation. All rights reserved. SLA and the 3D logo are registered trademarks of 3D Systems, Inc. and 3DPrint, 3DManage, Lightyear, ProCure, Viper, iPro and Zephyr are trademarks of 3D Systems, Inc.



iPro™ 8000/9000 SLA® Center User's Manual



Thank you for purchasing the iPro™ 8000 SLA® Center. Before using this equipment, please read this guide carefully to enjoy optimum performance and longer service life.

Table of Contents

[Introduction](#)

[What's Inside?](#)

[iPro SLA System's Features - RDM](#)

[Other Useful Documents](#)

[General Safety](#)

[Laser Safety](#)

[Chemical Safety](#)

[Environmental Conditions](#)

[Operations](#)

[Software Overview](#)

[View Port and View Object](#)

[Menu Bar](#)

[Tool Bar](#)

[Manual Operations](#)

[Scanner](#)

[History](#)

[Machine Window](#)

[Build Window](#)

[Mechanical Process](#)

[Troubleshooting](#)

[Customer Support](#)

[Service](#)

[Maintenance](#)

[System Block Diagram](#)

[Electronic Chassis Diagram](#)

[Legal Notices](#)

[Glossary](#)

[Specifications](#)

[Index](#)



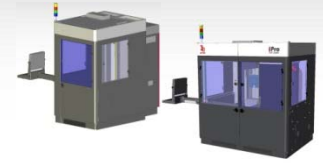

Introduction to the iPro™ 8000/9000 SLA® Center

Stereolithography - From *stereo*, for three-dimensional, and *lithography*, for printing, *stereolithography* is literally *three-dimensional printing*. It is the term used to describe 3D Systems' patented fabrication process that "prints" three-dimensional, solid objects by solidifying liquid plastic using a computer-directed, ultraviolet (UV) laser beam to cure successive layers of photo-sensitive polymer resin in an RDM (Resin Delivery Module).

The process "builds" three-dimensional solids from the bottom up, layer by layer. As each layer is created and super-imposed on the layer underneath, a solid object in the shape of a three-dimensional part is created, the origination of which typically occurs in a separate, computer-based modeling application such as CAD, CAM, or CAE. Layer thickness can range (see the [specifications](#) for details). A laser beam solidifies the layer of resin. The vertical elevator system lowers the newly formed slice beneath the surface of the resin at a distance determined prior to part building. A recoating system ensures consistent layer thickness. Layers build up until all the data for the model is processed. Then the part is drained and removed from the iPro 8000/9000 SLA Center for post-processing. The iPro 8000/9000 SLA Center consists of an assembly of numerous discrete sub-systems that are integrated to perform 3-D stereolithographic model generation.

Developed in 1987 by the founder of 3D Systems, stereolithography was the first commercially available layer-additive process to enable rapid fabrication of objects pulled directly from Computer-Aided Design databases.

Our products and services are used by marketing professionals, purchasing departments, engineering groups, research and development efforts, and design and testing teams all over the world... to turn their CAD, CAM, CAE designs ---their *IDEAS*---into solid, tangible, plastic objects.

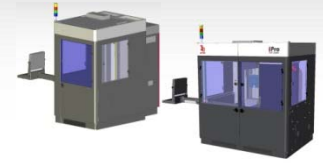

What's the difference?

The numerous build configurations available from the two iPro systems featured in this manual offer a broad range of options to produce high-definition plastic parts with unmatched quality and accuracy. They use the same mechanical hardware, software, and methodology. The difference is the size, and the options associated with size.

The iPro 9000 doubles the build zone of the iPro 8000 by allowing for 2 RDMs or an extra large RDM. With the greater size, parts can be created in two separate RDMs simultaneously, regardless of multiple part designs or resin materials. The iPro 9000 can also be used with a combined RDM to produce parts up to 60 inches long.

The two iPro systems are designed to fit the variety of needs in production and the ever-changing array of environments they run in.

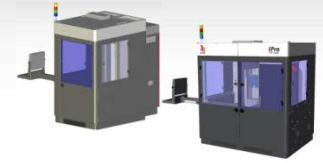

What's Inside?

This manual includes the following topics:

Latest Features

“[iPro SLA Center's Features](#)” describes the latest features incorporated into the iPro 8000/9000 SLA Center, such as the resin delivery module (RDM), Intelligent Resin Container, Recoater, and Scanning System. These features are improvements over previous SL models.

Many Other Useful Documents

In “[Other Useful Documents](#)” you'll find a listing of many other documents that may be helpful to you as you use the iPro 8000/9000 SLA Center, such as iPro 8000/9000 SLA Client Online Help, the Facility Requirements Guide, and Material Safety Data Sheets.

Need more information?



Contact Us

Operations

“[Operations](#)” describes your new iPro 8000/9000 SLA Center. Pictures of the iPro 8000/9000 SLA Center's components will help you understand the function of the various parts.

Software

“[Software Overview](#)” gives you a detailed overview of the software that operates your iPro 8000/9000 SLA Center.

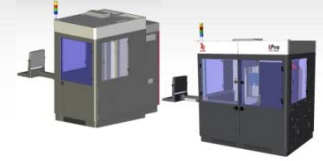

Recoater System

“[Recoater System](#)” describes how to perform different operations with the resin delivery module (RDM).

Safety

“[General Safety](#)”, “[Laser Safety](#)”, “[Chemical Safety](#)”, and “[Environmental Conditions](#)” describe precautions that you should take when using your new iPro 8000/9000 SLA Center.

Service and Troubleshooting

In “[Troubleshooting](#)” and “[Service](#)”, you will find the troubleshooting guide and other basic information concerning service and maintenance for your iPro 8000/9000 SLA Center.

Glossary

The “[Glossary](#)” defines terms that describe the iPro 8000/9000 SLA Center and its operations. After the glossary, you will find the “[Technical Specifications](#)” for your iPro 8000/9000 SLA Center.

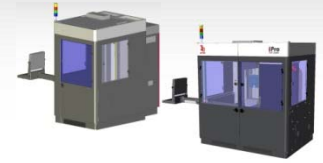

iPro 8000/9000 SLA Center's Features

Resin Delivery Module (RDM)

The RDM is a vital system component. It is the mobile container that stores the resin material and is rolled into the iPro™ SLA® Center to build parts.

The older generation SLA systems referred to this container as a "Vat" because it was basically just a square metal tub. The RDM is much more than just a container, it stores all the components that contact the build material as well as using identification electronics to communicate to the iPro SLA Center. This allows the system to detect **when** the RDM is installed, the **type** of RDM being used, and the **material** contained within the RDM.

The iPro 8000/9000 SLA Center allows for the faster material changes because of the innovative mobile design of the RDM. Not only can you now change resin in less than ten minutes, you can also swap the resin delivery module (RDM) easily, with no tools required. All components that come into contact with resin in the RDM are moved with the module itself. You can remove the RDM easily and quickly and replace it with another active RDM, without having to clean any wet resin surface. This new RDM design significantly reduces the time to swap between build materials. In addition, you can warm up an RDM offline, enabling you to swap one resin delivery module for another that is ready to use. Gloves, however, may be required to detach the Zephyr™ recoater blade. This new handling method ensures that all parts that come into contact with resin under normal operation are a part of the active RDM.



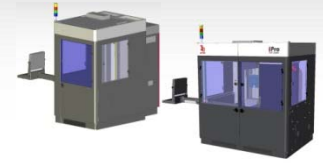

Table 1, shown below, lists the required build envelopes that represent all RDM and platform elevator configurations that the iPro 8000/9000 SLA Center supports. Each RDM and platform elevator design minimizes the amount of resin that the iPro 8000/9000 SLA Center requires.

Table 1: RDM Configurations

Name	Maximum Build Volume	Fill Capacity
RDM 650M	650 x 350 x 300 mm (25.6 x 13.7 x 11.8 in)	148 liters (39.1 U.S. gal)
RDM 750SH	650 x 750 x 50 mm (25.6 x 29.5 x 1.97 in)	95 liters (25.1 U.S. gal)
RDM 750H	650 x 750 x 275 mm (25.6 x 29.5 x 10.8 in)	272 liters (71.86 U.S. gal)
RDM 750F	650 x 750 x 550 mm (25.6 x 29.5 x 21.65 in)	414 liters (109.3 U.S. gal)
RDM iPro 9000 XL	1500 x 750 x 550 mm (59 x 29.5 x 21.7 in)	935 liters (247 U.S. gal)



The iPro 9000 XL builds large, single-piece parts up to 60-inches long with all of the performance attributes and accuracy that users have come to expect from 3D Systems' high-definition Stereolithography process. This system delivers extra-large parts with no seams for aesthetic superiority, one-piece durability, resulting in reduced labor and decreased cost. This RDM is only available for use in the iPro 9000 SLA Center.

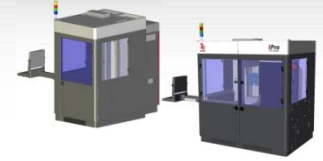

There are two operating modes for the RDM:

Stand-by Mode

In this mode, the RDM is offline and operates independently from the iPro 8000/9000 SLA Center, permitting offline resin and module temperature stabilization when it is connected with line power to the power umbilical. The resin can warm effectively in this mode, enabling the user to build a part while warming resin for future use.

Build Mode

In this mode, the RDM is online and connects to the iPro 8000/9000 SLA Center for power and I/O for full interoperability. The iPro 8000/9000 SLA Center monitors and controls the resin temperature while connected with the active RDM. When the RDM is online, it can pump and recirculate resin.

Intelligent Resin Container

Each container in the iPro 8000/9000 SLA Center holds an electronic storage device that has information about the resin that is in the bottle and the RDM. This information enables the iPro SLA Center to make sure that the user does not use the wrong material, use material incorrectly, or use an empty or expired container.



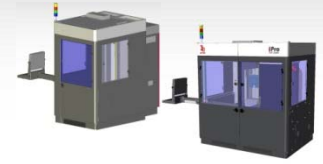

Single Resin Delivery Module

The iPro 8000/9000 SLA Center builds with one resin delivery module, focusing on speed and accuracy, without compromising space requirements.



Dual Resin Delivery Module

The iPro 9000 SLA Center can also build parts in two separate build zones, Build Zone A and Build Zone B. Each zone is independently capable of supporting its own active resin delivery module and motion axis control, enabling controlled builds in both zones simultaneously, with each build using different resins if desired.

Extra Large Resin Delivery Module

The iPro 9000 SLA Center can operate so that two build zones combine into a single larger build zone to create larger parts that make up a single contiguous envelope. The extra large resin delivery module accommodates a build zone of 1500mm x 750mm x 550mm.



Need more information?



Contact Us

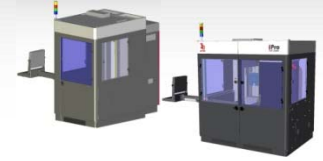

Recoating Module

The recoater system has a Zephyr™ recoater blade with four axes of motion: The y-axis moves the recoater blade front to rear; the z-axis moves it up and down; the theta y-axis tips or rotates the blade about the center; the x-axis motion directs sensor motion on the blade. The recoater system's liquid level sensor maps the resin surface by moving around the resin surface. The sensor calibrates the position of the blade so that the blade moves perfectly parallel to the resin surface, enabling the build to be accurate and precise. The recoating system uses the motion axes that are connected to the blade, enabling the system to self-calibrate and permitting a customized setting of the blade gap, or distance from the blade's bottom to the resin surface, for different resins.



IPM

The iPro 8000/9000 SLA Center's IPM (Image Projection Module), directs the laser beam using directional, focusing optics, and scanning mirrors, along with an AOM (Acoustical Optical Modulator) to regulate the output power. This process will accurately reproduce the input CAD data one layer at a time.

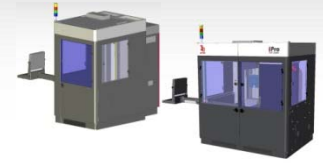

Other Useful Documents

The following documents will help you to achieve maximum proficiency with your iPro 8000/9000 SLA Center.

3DPrintTM Online Help

Run the iPro 8000/9000 SLA Center software, then select **Help > Help Topics** in the software window or the 3DPrint Preview window to launch iPro 8000/9000 SLA Center client online help. The online Help provides detailed instructions on how to use the iPro 8000/9000 SLA Center software to set up, run, and manage print jobs.

iPro 8000/9000 SLA Center Facility Requirements Guide

To see what preparation you must do at your site prior to installing the iPro 8000/9000 SLA Center, read the [Facility Requirements Guide](#).

For access,  **Want to know more?**
Click here for more info!

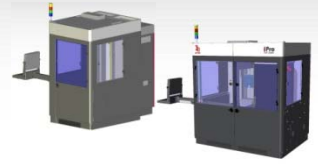

iPro 8000/9000 SLA Center Material Safety Data Sheets (MSDSs)

Make sure that everyone in your facility who handles iPro 8000/9000 SLA Center materials reads these MSDSs and follows the safety guidelines in them. Every resin shipment includes MSDS paper copies. You can also find an electronic copy of MSDSs on our Web site, [Material Datasheets](#).

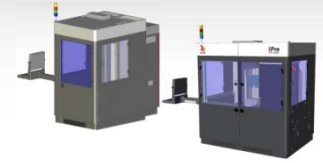

General Safety

Hazard Messages

There are four safety hazard messages in this iPro 8000/9000 SLA Center User's Manual: Also see "[Safety Labels](#)" for descriptions of safety labels on your iPro 8000/9000 SLA Center.



Damage

Machine damage, part damage, and/or data loss can result if you ignore this type of hazard message.



Electric Shock

Injury or death from electric shock can result if you ignore this type of hazard message.



UV Radiation

Eye injury or blindness can result if you ignore this type of hazard message.



Irritant

Bodily irritation or allergic reaction can result if you ignore this type of hazard message.

Always follow the safety procedures. Do not, in any way, risk injury by working dangerously. Safety is a part of work, and not an obstacle to it.

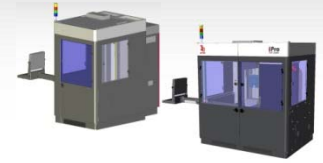

The iPro 8000/9000 SLA Center was designed with safety in mind; however, improper use and malfunctions can cause injury. To prevent unsafe operation, the iPro 8000/9000 SLA Center automatically shuts down immediately if it detects an unsafe condition.

Follow these general safety guidelines when operating your iPro 8000/9000 SLA Center:

- Read and follow system instructions.
- Follow all safety rules in this section and heed all cautions and warnings in this guide.
- Do not attempt to open the chamber door or windows while a part job is running.
- Do not use any material without first reviewing its [Material Safety Data Sheet \(MSDS\)](#).
- Dress power and communication cables at the back of the iPro 8000/9000 SLA Center to prevent tripping.
- Do not attempt to access, service, or adjust the internal components.
- Do not attempt to perform any maintenance procedures unless you have been specifically trained to do so.
- Operators are trained to operate the system and to perform all the necessary tasks to build a part.
- Certified service personnel have completed the 3D Systems service training package and are certified to perform service tasks. Certification may occur at various levels and servicers should only perform tasks that they are authorized and certified to complete.
- Do not ignore warning signs that are posted during service operations.

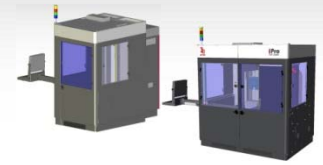

- If you see an error message on the system's display, refer to [Troubleshooting](#) before resuming operation.
- To prevent potential skin irritation and sensitization due to contact with waste material, follow all guidelines in the iPro 8000/9000 SLA Center [Material Handling Safety](#) and [Material Disposal Safety](#).
- To prevent pinch and crush injuries to the hand, use caution when replacing the platform inside the build chamber. The platform carriage will not move when the chamber door is open.

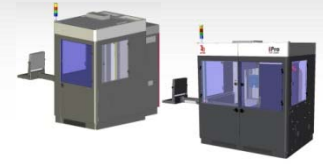

Laser Safety

The SLA Center is designated as a Class I Laser Device by the U.S. Center for Devices and Radiological Health (CDRH). Class I devices are not considered harmful and require no special safety precautions. Under normal operation conditions, the laser beam is completely confined. The viewing windows in the Process Module, block the UV laser radiation from exposure outside of the build area(s).



Radiation

Operating the equipment or performing procedures other than those specified within this guide may result in exposure to hazardous, invisible laser radiation.



Radiation

Never stare directly into a laser beam, nor into any beam reflection, whether diffused or from a mirrorlike surface.

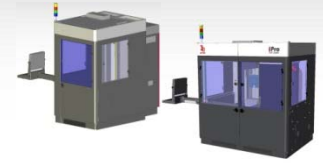

Radiation

During normal operation, and with all panels installed, the iPro 8000/9000 SLA Center is classified as a Class I laser device. If any of the interlocks are defeated, the iPro 8000/9000 SLA Center becomes a Class IV device. Eye damage can occur by looking directly into the beam or by viewing any type of beam reflection.



Radiation

Interlocks are to be defeated only by trained personnel when needed during service procedures.

Control Switches

The locations of control switches are described in the [Operations](#). Master and Emergency power shut-off switches are located as described in the following paragraphs.

Master Power Shut-off

The iPro SLA Center has a master circuit breaker switch located on the electrical cabinet module.

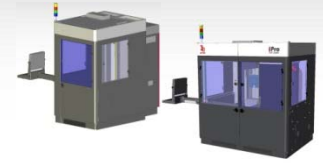

Emergency Shut-off

All SLA Centers have an Emergency Shut-off button on the front panel of the Control Module/ Bay. The iPro 8000/9000 SLA Center has an additional Emergency Shut-off button inside the Process Chamber. They are bright red with a yellow background. Pressing either switch cuts off all electrical power to the system, including the laser. See “[Safety Labels](#)”.



Caution

This method of power shut-off is not recommended and should be used only in an Emergency situation.

To restart the system after an emergency shut-off:

Rotate the Emergency OFF button clockwise to reset it, then press the **System Enable**.

Control Panel Laser LED

An LED light displays the current status of the laser power availability at the laser power supply.

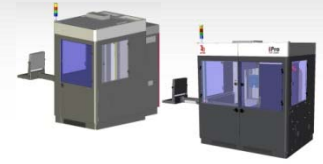

Safety Warning Labels

Laser safety warning labels for the iPro 8000/9000 SLA Centers are affixed inside the process module and RDM. On the iPro 8000/9000 SLA Center, labels are affixed on the frame behind the RDM door and near the aperture at the top of the process chamber. These labels conform to the requirements for Class IIIb and Class IV lasers. Refer to "[Safety Labels](#)" for their location.

Safety Interlock Switches

Safety interlock switches protect the user from possible UV laser radiation exposure when certain doors or panels are opened. See "[Safety Labels](#)" for their locations.

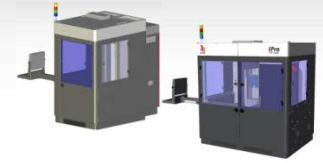

Safety Labels & Interlocks

Safety labels are attached at the places shown.



An **interlock** is located close to each label.

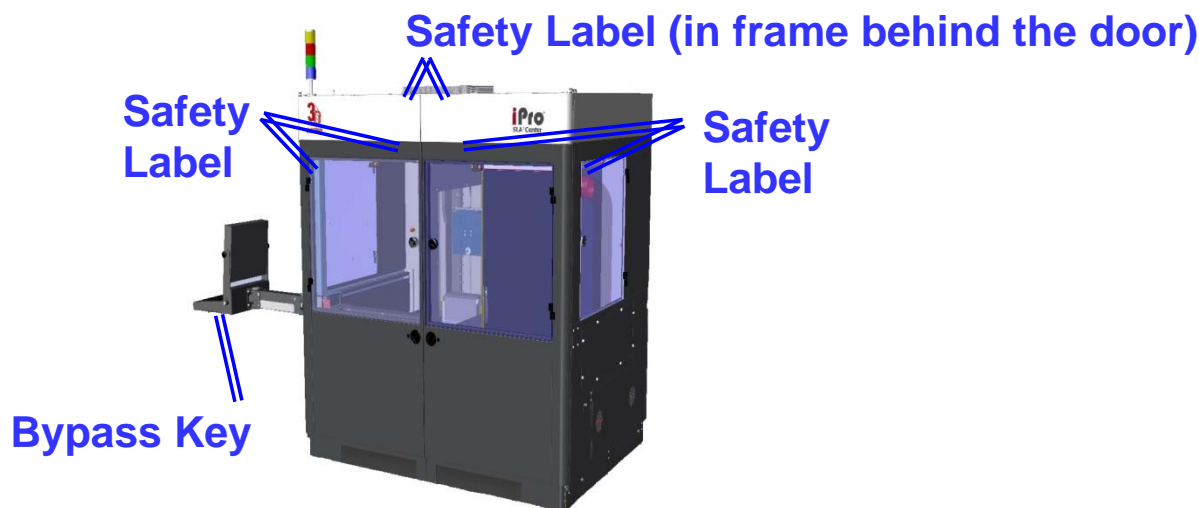

The machine **bypass key**. **Note: when this key is in bypass mode, the safety interlock switches are not active.**



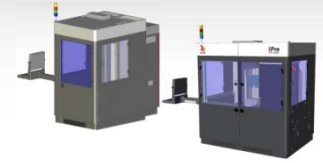

Chemical Safety



Irritant!

Always wear chemical-resistant gloves, goggles, and protective clothing when handling resin. Avoid skin contact. Avoid breathing resin fumes.

- Always wear approved goggles, nitrile gloves and protective clothing when working near resins or with partially cured parts. Epoxy resin is less viscous and splashes more easily than acrylate resin.
- Wearing contact lenses when working with resins is not recommended.
- Always wear chemical-resistant gloves whenever handling resins or partially cured parts. Recommended gloves are 100% Nitrile. Do NOT wear latex gloves.
- Always work in a well ventilated area when using resins. Avoid breathing vapors.
- Always wash skin thoroughly with abrasive soap and COLD water after working with resins. DO NOT USE HOT WATER OR SOLVENTS to wash hands, as it will result in absorption through the skin.
- Use extreme care when handling solvents used to remove excess resin from uncured parts. These solvents (e.g., denatured alcohol, isopropyl alcohol) are very flammable.
- Keep all resins away from heat, sparks and flame. Resin containers may rupture when exposed to extreme heat.



Use National Fire Protection Association Class B extinguishers such as carbon dioxide, dry chemical, or foam.

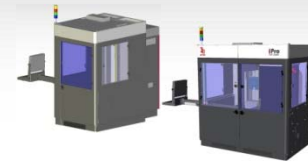

Resin Characteristics

The photopolymers used in stereolithography may be hazardous if handled improperly. Repeated skin contact with resins may cause sensitization. Consult the manufacturer's [Material Safety Data Sheet \(MSDS\)](#) for information on specific resins. For further information on this and related topics, consult the [3D Systems – Materials](#) website.

Resin Storage

Resin should be stored in opaque, non-reactive containers, according to the guidelines given in the MSDS included with the resin. Protect resin from sunlight and ambient room light. Resin may be stored in RDMs with the lid securely fastened. Pouring resin back into the original containers is acceptable, but be sure to leave several inches of air above the resin in the sealed container. This will leave room for expansion and also inhibits spontaneous polymerization for some resins. Always label resin by type and usage history.

Never mix different resins.

Resin Disposal

Do not dump used resin down any drains. Follow disposal rules established by company, local, state, and federal authorities.

Resin Spill Containment

Your company has the responsibility to define what constitutes a major spill. Personnel who are involved in cleaning up major spills of resin should wear NIOSH/MSHA approved respirators designed for use with organic chemical vapors. In addition, each person should wear protective goggles, rubber boots, and 100% nitrile gloves to minimize exposure to resin, which can cause eye, skin, and respiratory irritation, as well as possible skin allergies and respiratory reactions.

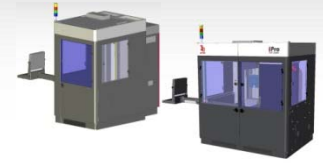

Caution!

Resin is combustible. Care should be taken during resin containment and cleanup operations.

A supply of dikes and control booms should be stocked so they are available to contain the affected area in the event of a major resin spill. The spilled resin should then be absorbed on inert absorbent material and placed into drums for transfer to an approved waste disposal site. After cleaning up the spill, individuals should wash thoroughly with soap and cold water. All clothing should be washed before reuse. Avoid exposure to sunlight until skin and clothing have been cleaned of resin. Refer to the MSDS before using any chemicals. Repeated or prolonged skin contact may cause sensitization. Vapor may be harmful.

First Aid and Protective Equipment

The following paragraphs provide general first aid procedures and recommendations for protective equipment to minimize the risks from resin exposure. If professional medical attention is necessary, take the [Material Safety Data Sheet \(MSDS\)](#) for the exact resin involved to the attending physician.

Skin Contact

Wear 100% nitrile gloves and lab coats to avoid skin contact. Should resin come in contact with skin, wash thoroughly with soap and **cold** water and immediately remove contaminated clothing and shoes. If skin is irritated, get medical attention. Dry-clean contaminated clothing. Discard contaminated shoes and leather products.

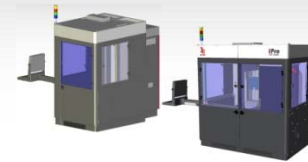

Eye Contact

Safety goggles should be worn to prevent accidental splashes into the eyes. If resin comes in contact with the eye, flush immediately with large amounts of water for 15 minutes, avoid sunlight, fluorescent light, and other ultraviolet light, and obtain immediate medical attention. Eye wash facilities and a first aid kit should be readily available and close to the resin.

Contact Lenses

If resin splashes into the eye when contact lenses are worn, flush the eye with water immediately. Verify that flushing has removed the contact lens from the eye. Protect eyes from light and obtain immediate medical attention. Discard contact lenses that come into contact with liquid resin.

Fume Inhalation

Remove the person to fresh air. Give artificial respiration or cardiopulmonary resuscitation (CPR) if required. If breathing is difficult, give oxygen. Obtain immediate medical attention.

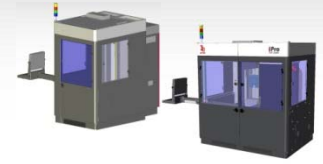

Environmental Conditions

Temperature

To allow optimum systems operation and optimum part quality, the temperature of the iPro 8000/9000 SLA System's room or other location should remain stable. The working range is 23°C +/- 3°C (73°F +/- 5°F). Any temperature fluctuation greater than 3°C may adversely affect parts built on the system.

The air conditioning system should maintain a temperature change of less than 1°C per hour. The stereolithography room should have a minimum cooling capacity of 1.4 kW. We recommend an HVAC system that changes the air two to five times per hour. To avoid adversely affecting part quality, do not expose the iPro 8000/9000 SLA system to direct air flow from the air conditioning system.

Beyond the temperature range that is optimum for part quality, the system is capable of operating safely without creating a hazard between 5°C and 40°C.

Humidity and Altitude

The optimum humidity in the iPro 8000/9000 SLA Center build chamber depends partly on the SL material selection, although humidity should always be non-condensing and should not vary outside the range of 20-50% for optimum part quality with most resins. The system can operate at higher non-condensing humidity levels but may adversely affect part quality. Review your iPro SLA Center material information, MSDS/SDS, product datasheet, and product labeling, for specific information on recommended humidity levels. The iPro 8000/9000 SLA Center can operate correctly up to an altitude of 1000m above mean sea level.

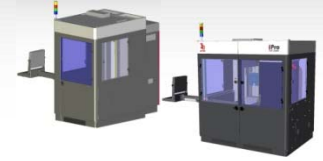

Operations

iPro 8000/9000 SLA Center

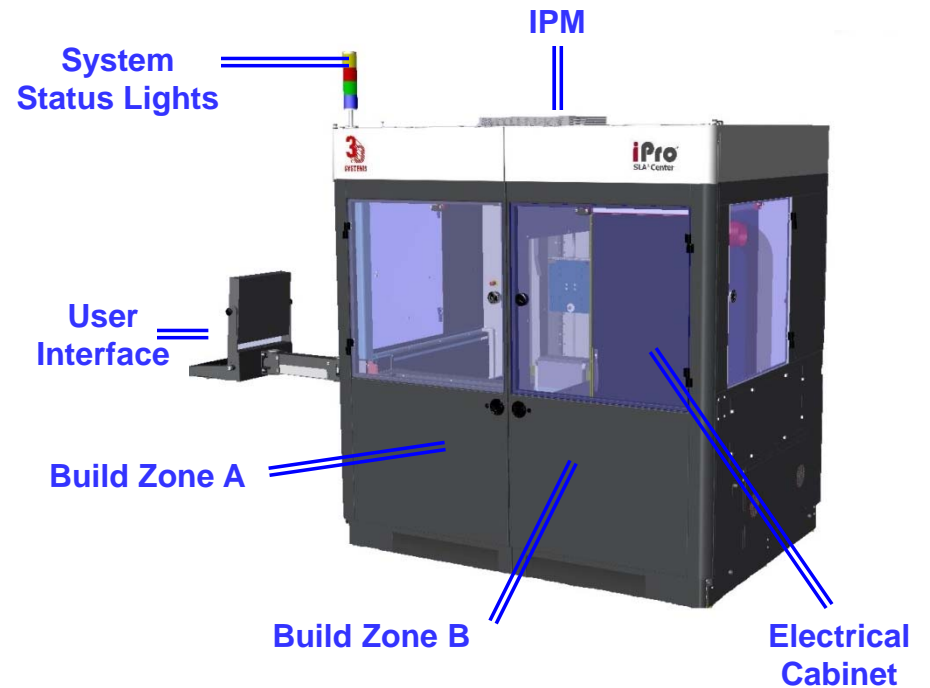
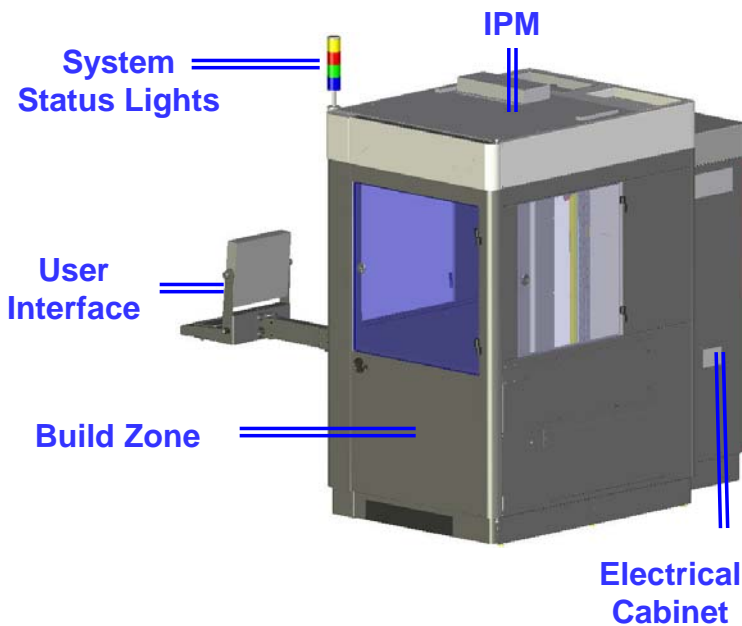

IPM: The iPro 8000/9000 SLA IPM (Image Projection Module) relays the drawing into information that will enable a build.

System Status Lights: System Status Lights indicate whether the build is occurring, and whether the machine is on or off, and what stage of the build is in process.

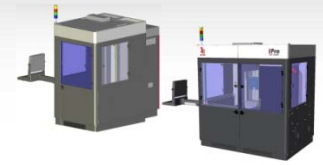

User Interface: The user interface enables you to program the criteria for the build, using 3D PrintTM software.

Build Zone A: Build Zone A is the left side of the iPro 8000/9000 SLA Center, as you face the Machine, and is utilized for the building of all machine configurations.

Build Zone B: Build Zone B is the right side of the iPro 9000 SLA Center, as you face the Machine, and is utilized for building with a dual or extra large machine configuration.

Electrical Cabinet: The electrical cabinet contains all the electrical equipment that the iPro 8000/9000 SLA Center requires. For the 9000, the location of the cabinet varies based on machine configuration. The cabinet can be located within the build zone B area for single RDM system. The cabinet is located behind the machine for any configuration, including the dual RDM option.

System Requirements

For system requirements, consult the [Facility Requirements Guide](#).

For access,  **Want to know more?**
Click here for more info!

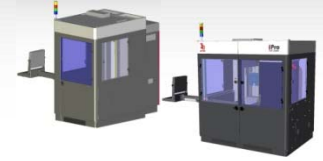

User Interface

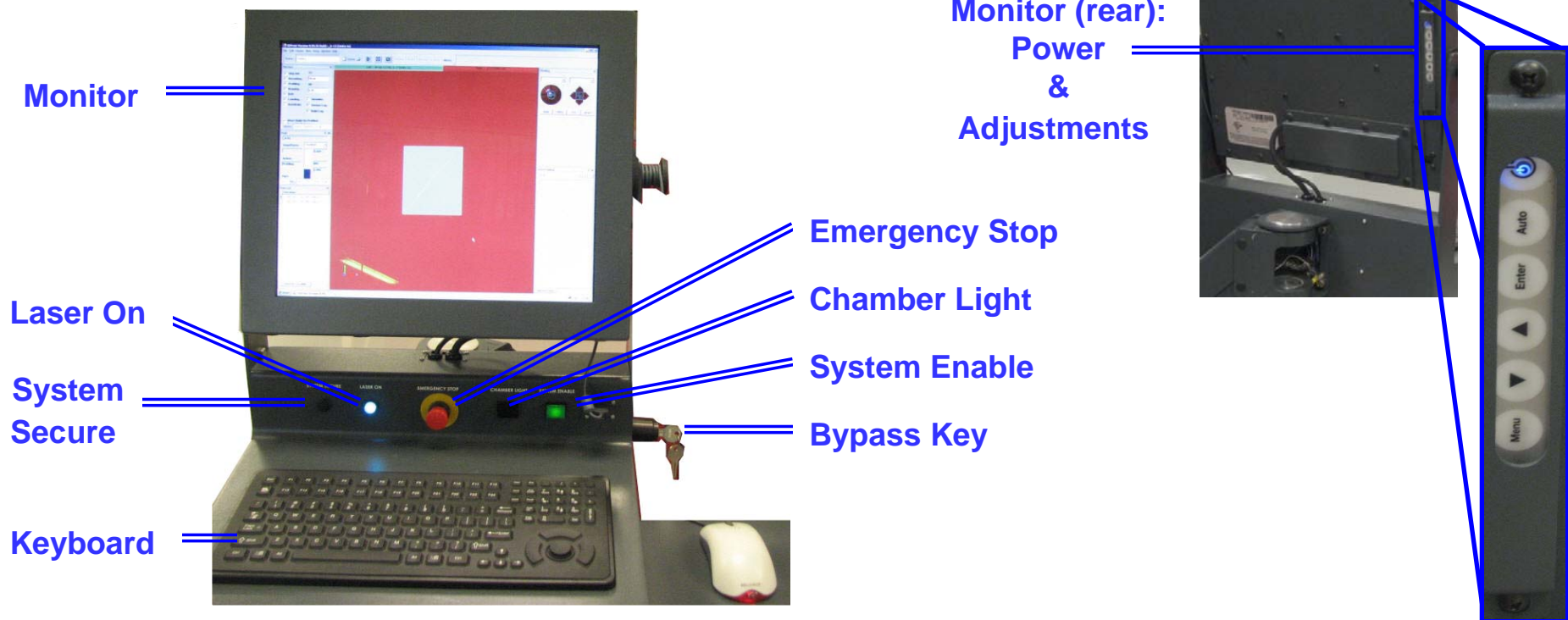

Monitor: The monitor, located above the keyboard, shows you the status of the build and the software required to start and complete the build.

Laser On: This indicator illuminates to alert the user when the laser is on.

System Secure: This indicator illuminates when the system is secure.

Keyboard: The keyboard, located below the monitor, enables you to enter commands.

Emergency Stop: This switch, located in the center of the user interface, immediately disables all hazardous machine functions or renders them safe. After being pressed, it remains in the closed state until it is manually returned to the open state.

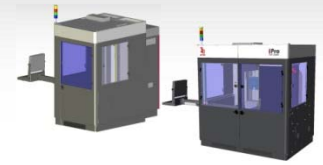

Chamber Light: This switch turns the chamber lighting on or off.

System Enable: This switch enables the system once the operational software has been launched. It also re-enables the system following an emergency stop, which occurs after the emergency stop switch returns to the open state.

Bypass key: If this key is in bypass mode, the safety interlock switches are not active.

Monitor (rear): The power and adjustments for the monitor are located on the back side of the monitor. To increase the life and quality of the monitor, turn the power off when not in use.



Note: The chamber lights can be repositioned to view specific areas as needed. Check the switch on the lights themselves if they do not come on when you press the button at the user interface.

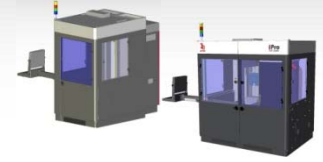

Resin Delivery Module (RDM)

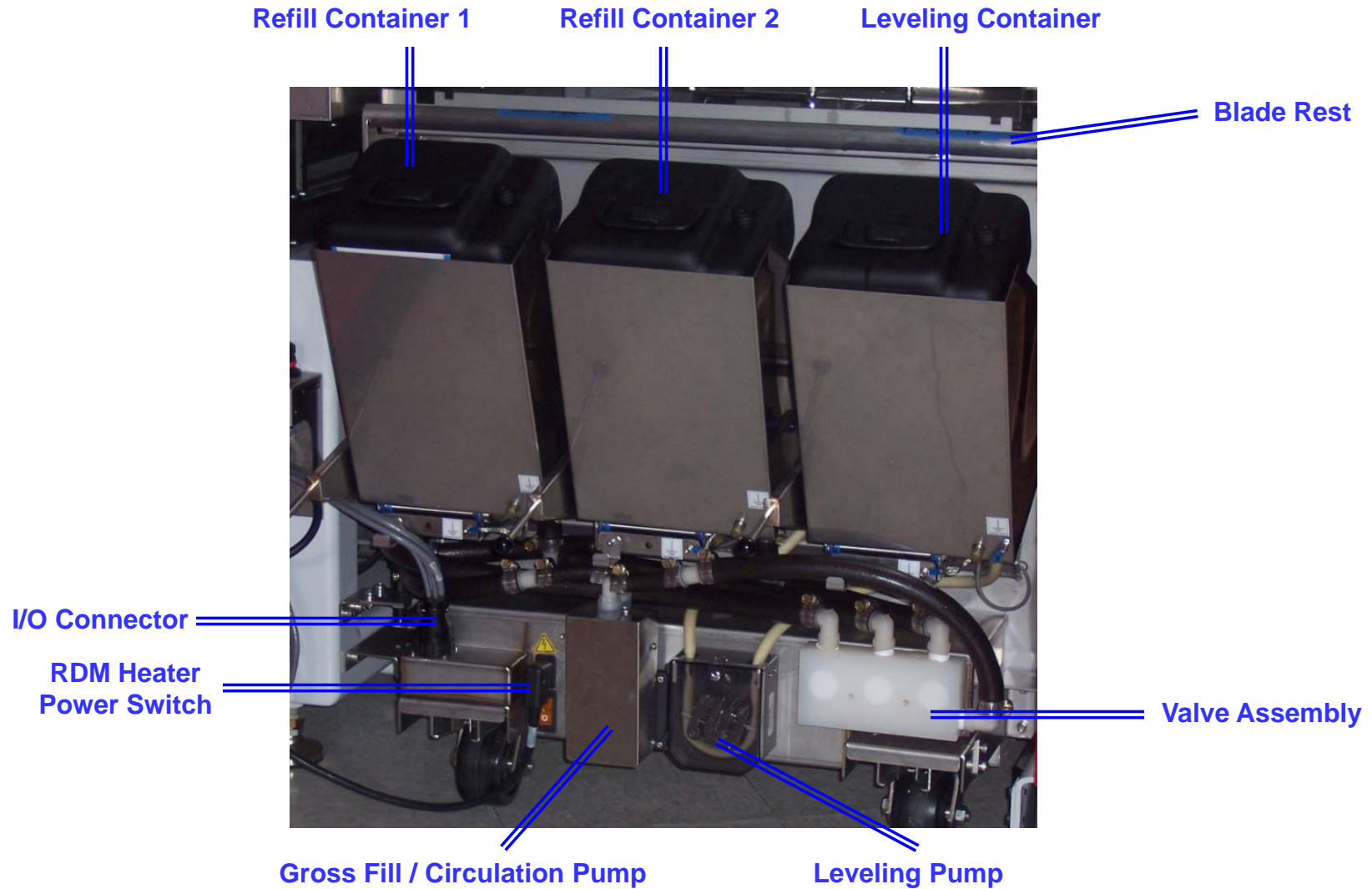

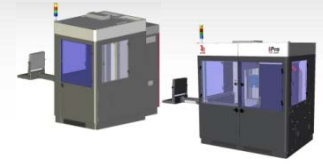

Refill Container 1 and 2: These removable containers store new resin, which is added to the RDM as needed, prior to the start of a build.

Blade Rest: The blade rest area is used to stow the removable recoater blade when changing RDMs.

Leveling Container: The system requires precise control of the resin height. This container acts as a storage reservoir.



Note: Under normal operations, this container is not to be removed.

Valve Assembly: These valves control the resin flow from the refill containers and recirculate resin.

Leveling Pump: The leveling pump controls the resin height in the RDM by moving resin to or from the leveling container.

RDM Heater Power Switch: This switch enables warm up of the RDM, whether in the system or offline.

I/O Connector: This connector is the interface for all communication and motion control between the RDM and the iPro 8000/9000 SLA Center.

Gross Fill/Circulation Pump: This pump transfers resin from the refill containers into the RDM, and recirculates resin already in the RDM.

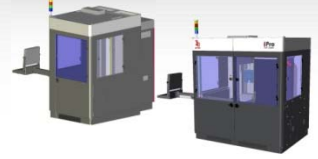

Electrical Cabinet



Main Power
Disconnect

Electrical Cabinet: Closed Door

Main Power Disconnect: The disconnect enables you to turn off all power to the system. Do NOT position the equipment so that it is difficult to operate the disconnecting device.

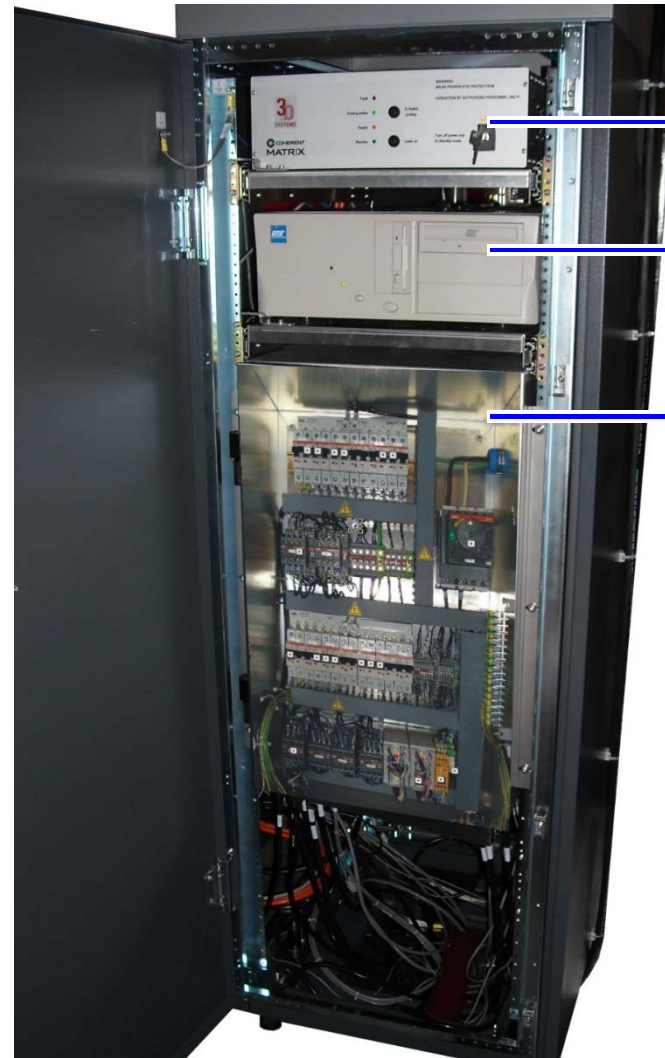
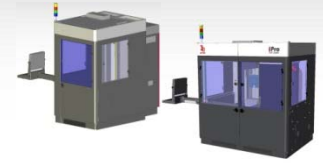

Laser Power Supply

Controller

Power Distribution

Electrical Cabinet: Open Door

Laser Power Supply: The laser power supply enables the user to turn on and off the power.

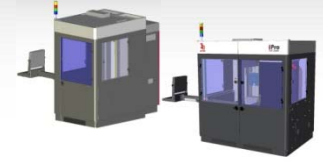

Controller: The computer operates the iPro 8000/9000 SLA Center.

Power Distribution: This module distributes all the AC power that the systems need. Circuits for the various subsystems are located in this module.

Laser Cooling System: The laser cooling system maintains the optimum laser head temperature. The air cooled units fans are located in close proximity to the laser head in the IPM.

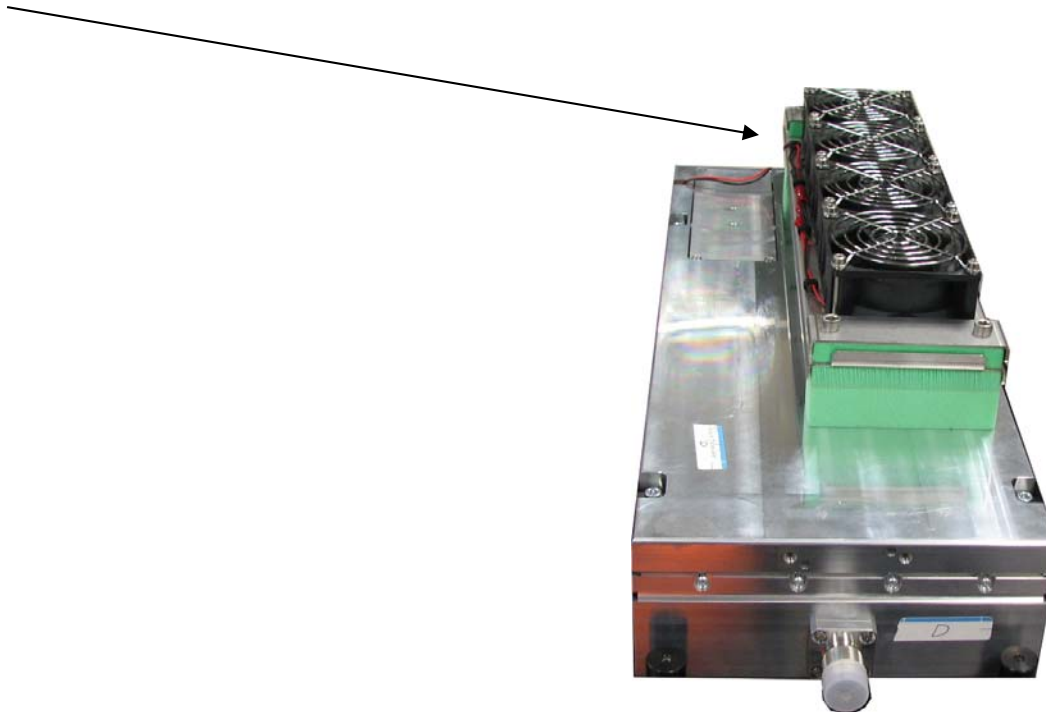

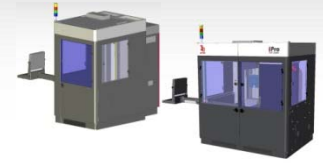

Manual Offload Cart



The **manual offload cart** is available as an option when you purchase an iPro™ SLA® Center. You can easily remove a platform from the SLA Center with a large or heavy part on it. This cart moves the platform and parts to the finishing area, where supports are removed and the part is cleaned before it is cured.

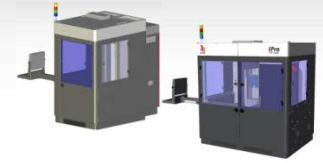

Software Overview

The next few pages describe the 3DPrint™ components, their location in the software, and their specific tasks.

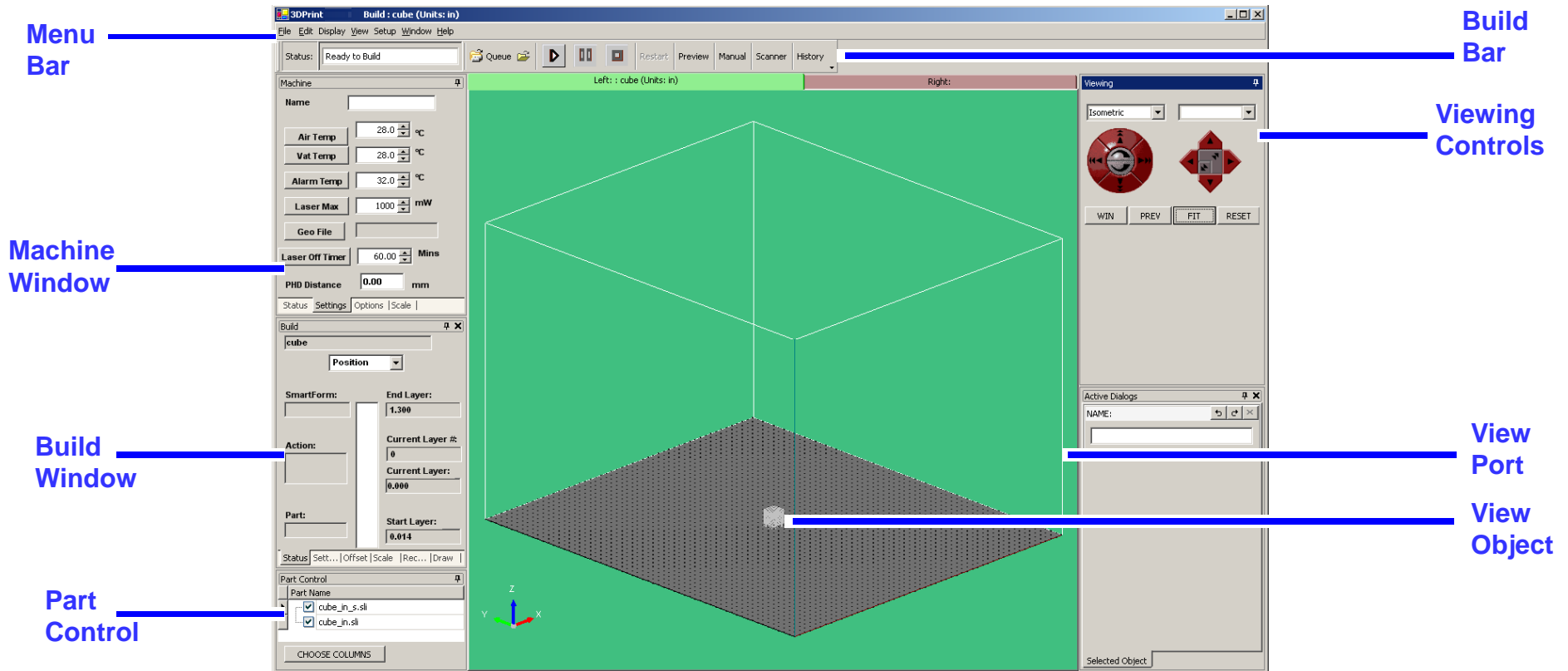

Main Screen of the 3DPrint™ Software

- Menu Bar
- Machine Window
- Build Window
- Parts List

- Tool Bar
- Viewing Controls
- View Port
- View Object

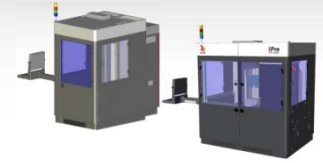

View Port and View Object

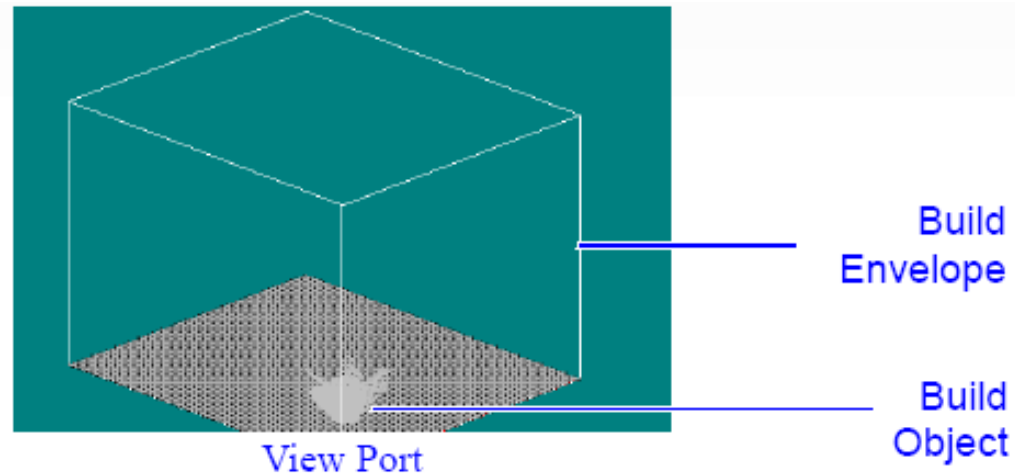

When the view port is the active window, the user can see the build in progress. The build envelope is the maximum space for part building. The build object is the part or parts that are being built. The build object in the view port can be controlled in three ways:

- Mouse
- Viewing Controls
- Mouse and Keyboard

Mouse

You can perform the following commands using the mouse:

To rotate View Port:

Right Mouse Button + Drag

To zoom View Port:

Click in the View Port; then move the scroll wheel.

[Software Overview](#)

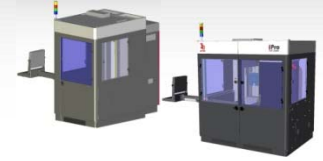

Viewing Controls

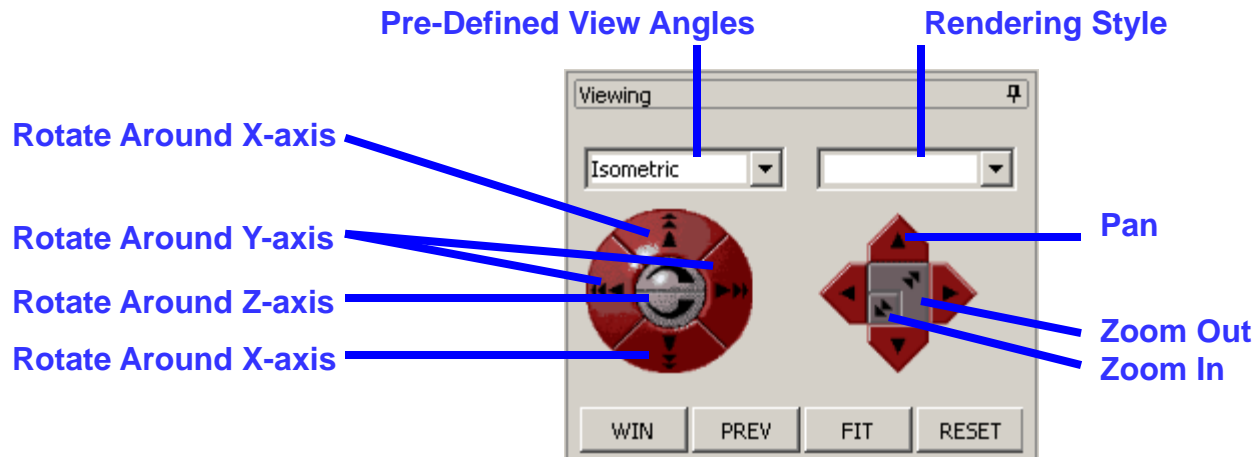

The Viewing Control and the mouse can give you control of the view port by rotating around the x-, y-, and z-axis; zooming in and out; panning left, right, up, and down; and viewing a predefined condition. Clicking and releasing gives you an instant response; clicking and holding gives you a continuous response.

To **zoom in or out**, click on the square in the middle of the right side of the control.

To **rotate**, click on the red outer circle on the viewing control's left side; then click on the arrow that describes what rotation that you want.

To **pan**, click on one of the pentagons on the right side of the viewing control; then click on the direction in which you want to pan.

[Software Overview](#)

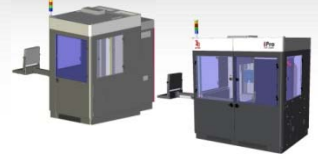

Mouse and Keyboard

To perform the following commands via mouse and keyboard:

Translate View Port:

Alt + Right Mouse + Drag

Zoom View Port:

Shift + Right Mouse Button + Drag

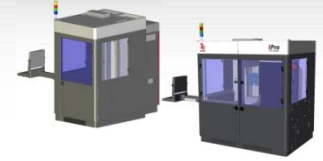

Menu Bar

File

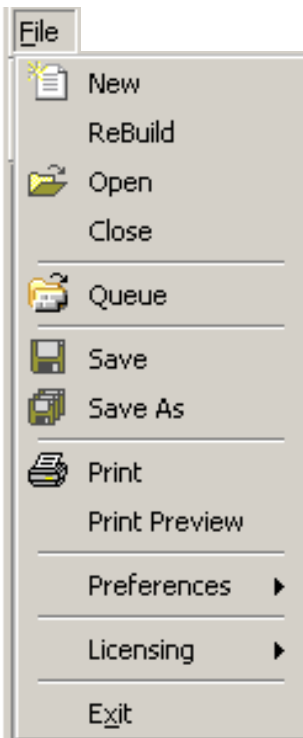

New: Clears current build file.

Rebuild: Reloads the last build file.

Open: Selects a new build file; prompts user to clear the current file, if current file is not closed.

Close: Closes the current build file.

Save: Saves your applied changes to the build file.

Save As: Saves your applied changes to the build file, under a different name.

Print: Prints the application window.

Print Preview: n/a

Preferences: See [Preferences](#).

Licensing: See [Licensing](#).

Exit: Terminates the software.

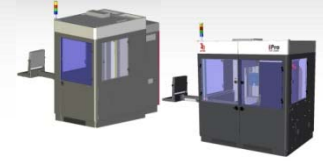

Preferences

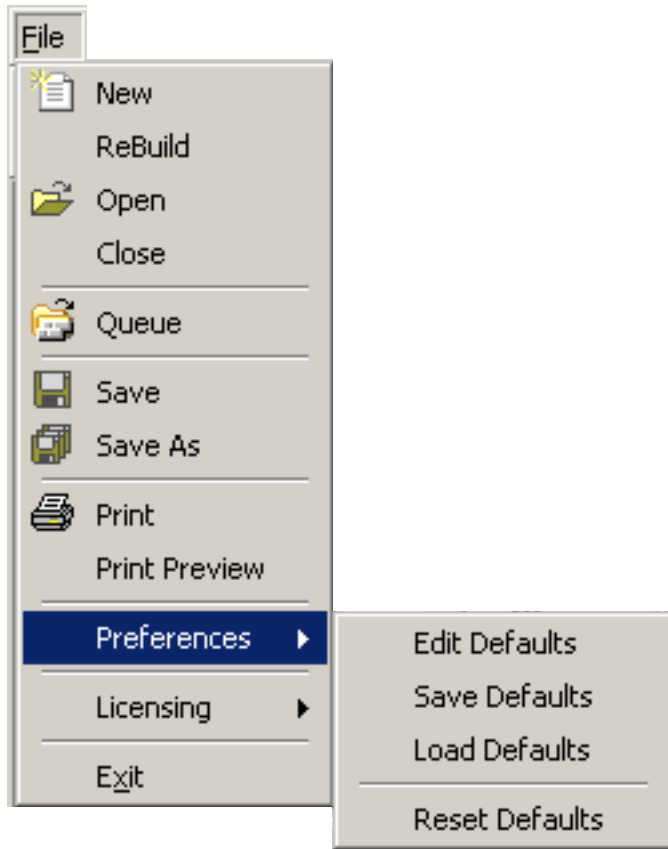

Edit Defaults: Edits the 3DPrint XML file.

Save Defaults: Writes out, or saves, the 3DPrint XML file.

Load Defaults: Loads the 3DPrint XML file.

Reset Defaults: Resets the 3DPrint XML file.

Preferences enables you to edit, save, load, and reset defaults.

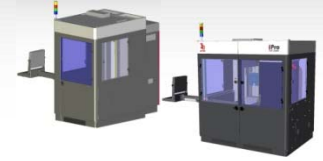

Licensing

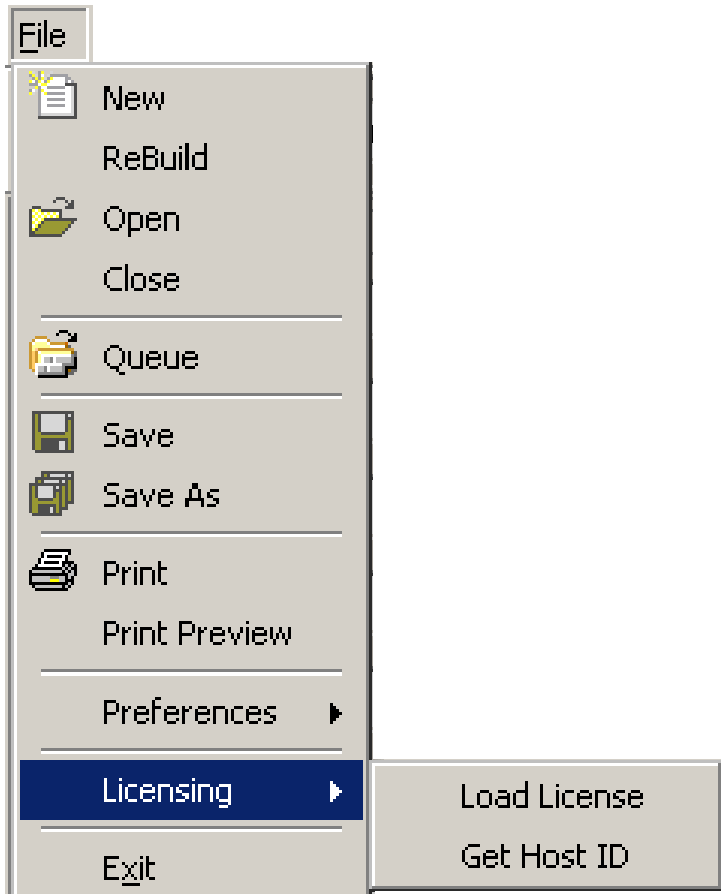

Load License: For initial software run only, enables user to load license and activate application; user must load license to use application

Get Host ID: Obtains ID of the computer user and places it in a text file

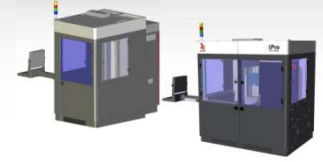

Edit

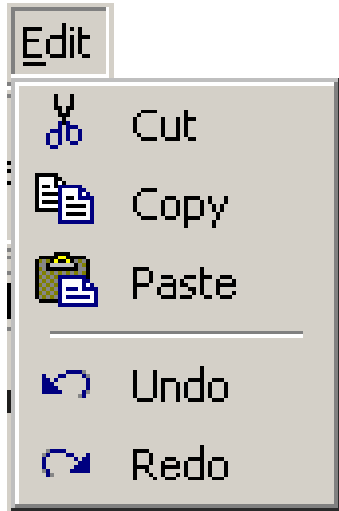

The **Edit** menu enables you to Cut, Copy, Paste, Undo, and Redo.

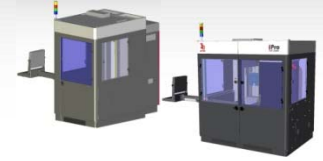

Display

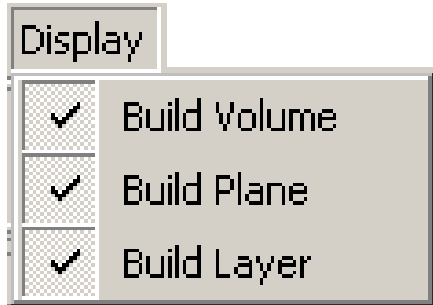

Build Volume: Toggles the display of the build volume.

Build Plane: Shows the z-height status of the part build during a build.

Build Layer: Displays image of the layer currently being built during a build.

The **Display** menu enables you to choose Build Volume, Build Plane, or Build Layer.

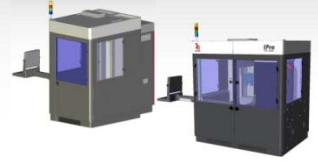

View

The **View** menu currently has no function.

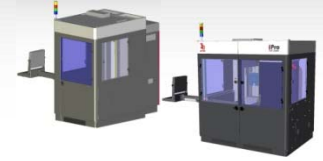

Setup

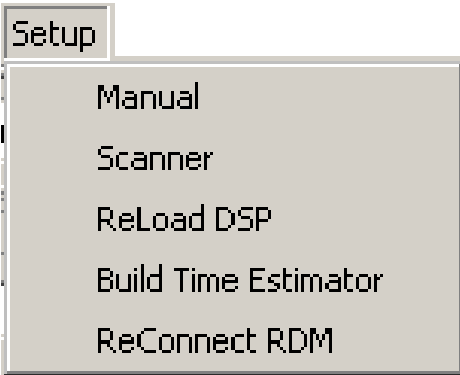

The **Setup** menu enables you to interact with the systems hardware through the use of the Manual and Scanner windows:

Manual: Opens the manual operations window; see [Manual Operations](#).

Scanner: Opens the scanner operations window; see [Scanner](#).

ReLoad DSP: Machine will re-initialize all hardware and communications without requiring a computer restart.

Build Time Estimator: Allows the user to create an estimated build time from a build file (.bff). This is disabled during the build cycle.

ReConnect RDM: Allows the user to re-establish communications to the RDM.

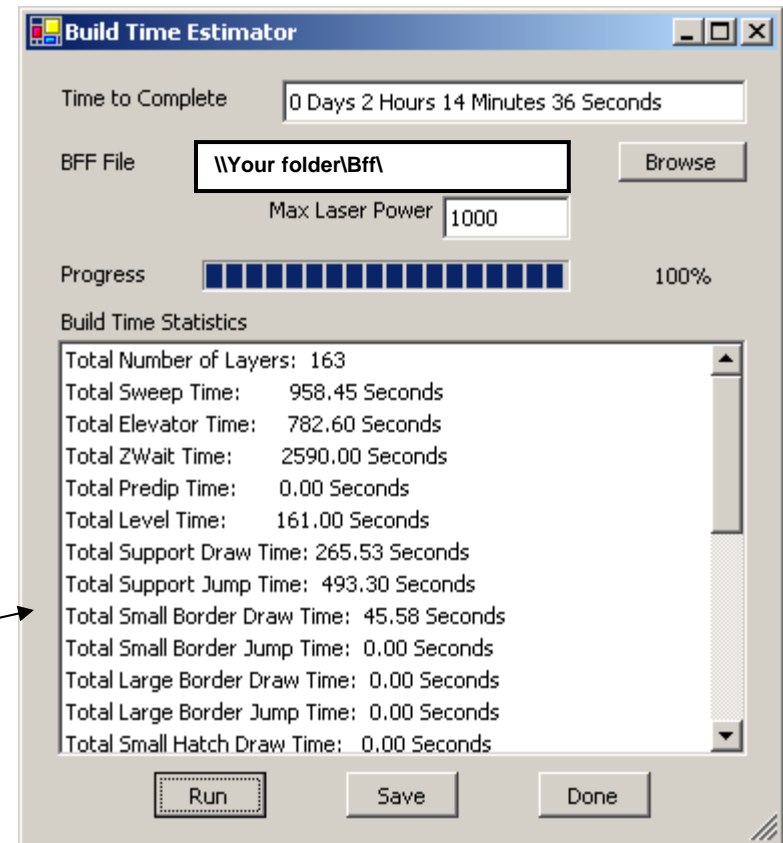

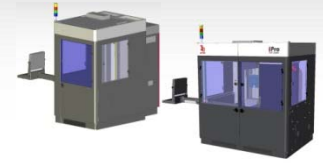

Window

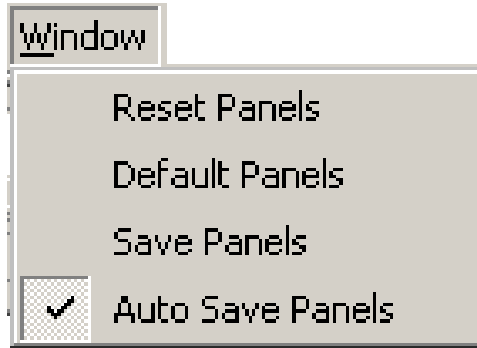

Reset Panels: Goes back to the panel that was saved

Default Panels: Goes back to the factory setting

Save Panels: Saves current panel setting

Auto Save Panels: When this box is checked, panel settings are automatically saved at the application's exit.

The **Window** menu enables you to reset panels, restore default panels, save panels, and Auto Save Panels.

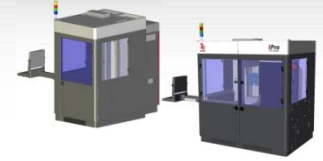

Help

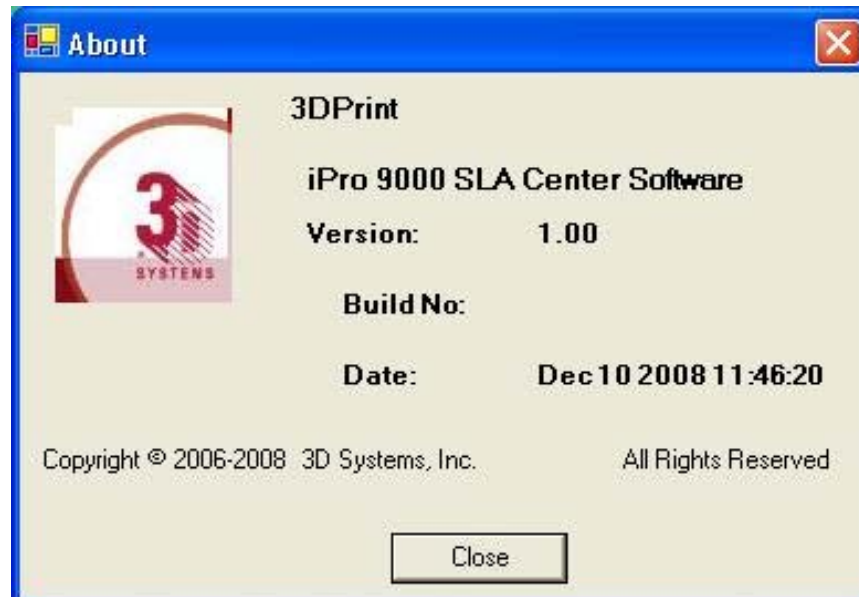

The Help menu gives you information about the 3DPrint software release.

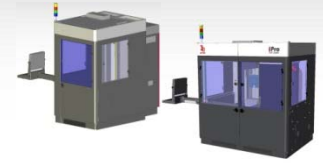

Tool Bar

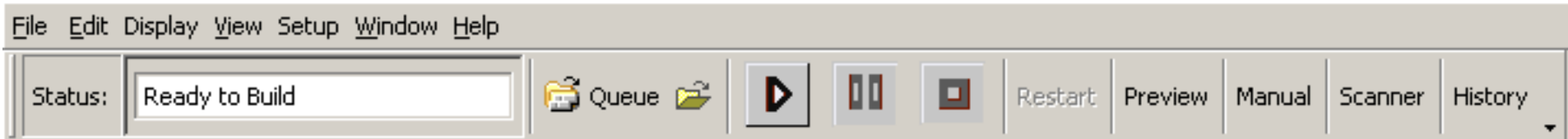

Play Pause Stop

Status: Shows machine status.

Queue: Lists the build jobs in the queue.

Open: Browse for a new build file; prompts you to clear the current file if one is currently open.

Play: Starts the build.

Pause: Pauses the build.

Stop: Clicking this button prompts for confirmation to stop; when **okay** is selected, the machine will stop at the end of the current function (drawing or recoating).

Restart: Enables the build to continue from where it was stopped.

Preview: Enables a display of the build on the screen.

Manual: Opens the manual operations window; see [Manual Operations](#).

Scanner: Opens the scanner operations window; see [Scanner](#).

History: Gives access to information on previous builds.

[Software Overview](#)

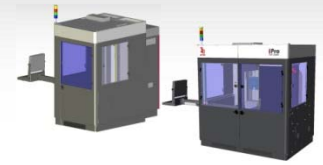

Manual Operations

Manual Operations - Left

Elevator

Position: ↑ ↓

Distance: Velocity: Minutes:

Action: Status: Elevator needs to be homed

Recoater

Position: ← →

Distance: Velocity:

Vacuum

Action: Status: Recoater needs to be homed

Leveler

High ↑

Level ↓

Low

Turns: Velocity:

Action: Status: Resin level is high.

Container 1: kg Container 2: kg Container 3: kg

Enable Crash Protection

Manual Operations, explained in more detail on the following pages, enables the user to make manual adjustments regarding the elevator, recoater, and leveler.

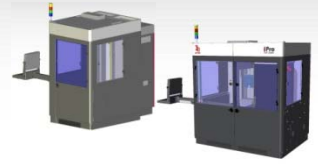

Damage

When **Enable Crash Protection** is turned off, the motion systems can collide and cause physical damage to parts of the system.

Use extreme caution when moving motion axes if *Enable Crash Protection* is unchecked. Damage caused by this type of collision is not covered under the 3D Systems' warranty.

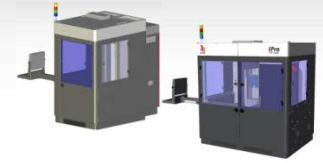

Elevator



The manual operations **Elevator** allows you to operate the elevator manually. "[Machine Window](#)", and the following textual explanations, show the command's functions. Be careful when entering values; if there is a safety limit, observe it. The software tells you to home the recoater, prior to moving the elevator.

To **Move** the Elevator, specify **Distance** and **Velocity**.

Position: Shows the current position of the elevator relative to the home position

The following buttons perform the actions to alter the position.

Stop: Stops all motion during the move.

UP/DOWN: Moves the elevator up/down by placing the cursor  over the intended direction and pressing and holding the left mouse button  until the intended elevator placement is achieved, or until the elevator reaches a direction limit.

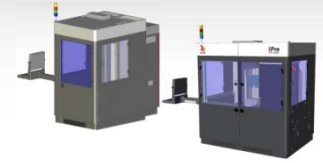

Move	HOME	Stir
Distance	Velocity	Minutes
0	1.0	15



Note: These values apply only to manual movement.

Move: Manually moves elevator as the user specifies.

Distance: Specifies distance, in inches or millimeters, from current position; negative moves elevator down, positive moves elevator up.

Home: Moves the elevator to the home switch and redefines the home position (relative zero position of the elevator)

Velocity: Specifies the elevator speed in inches or millimeters per second during manual motion; it does not affect motion during the move.

Stir: System will move elevator up and down in a stirring motion. To achieve this:

- using the move button, position the elevator to the upper most stir **position**
- enter the down **Distance** of the area to stir
- enter the **Minutes** for the amount of time for the stir to transpire
- press **Stir**.



Note: This will be ineffective if the build platform is not installed.

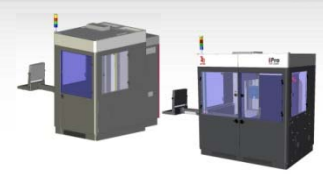

Start	Offload	AutoDrain
Set Start	Set Offload	Set AutoDrain
.000	.000	.000



Note: These functions will not work if elevator has not been homed.

Start: Moves the elevator to its Start position, as defined by Set Start.

Set Start: Saves the elevator's current location as the Start position; the field below the button displays the selected value for the Set Start position.

Offload: Moves the elevator to its Offload position, as defined by the position.

Set Offload: Saves the elevator's current location as the Offload position; the field below the button displays the selected value for the Set Offload position.

AutoDrain: Moves the elevator to its AutoDrain position, as defined by the position.

Set AutoDrain: Saves the elevator's current location as the AutoDrain position; the field below the button displays the selected value for the Set AutoDrain position.

Action:	Status: Elevator needs to be homed	Clear Faults
---------	------------------------------------	--------------

Action: Describes the current elevator action.

Status: Displays if the elevator has been reset by sending it to its *Home* location.

Clear Faults: Attempts to clear all errors within the elevators system.

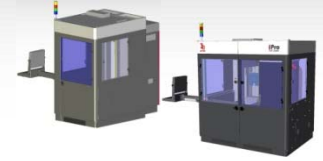

Recoater

The manual **Recoater** allows you to operate the recoater manually. The following pages show the command's functions.

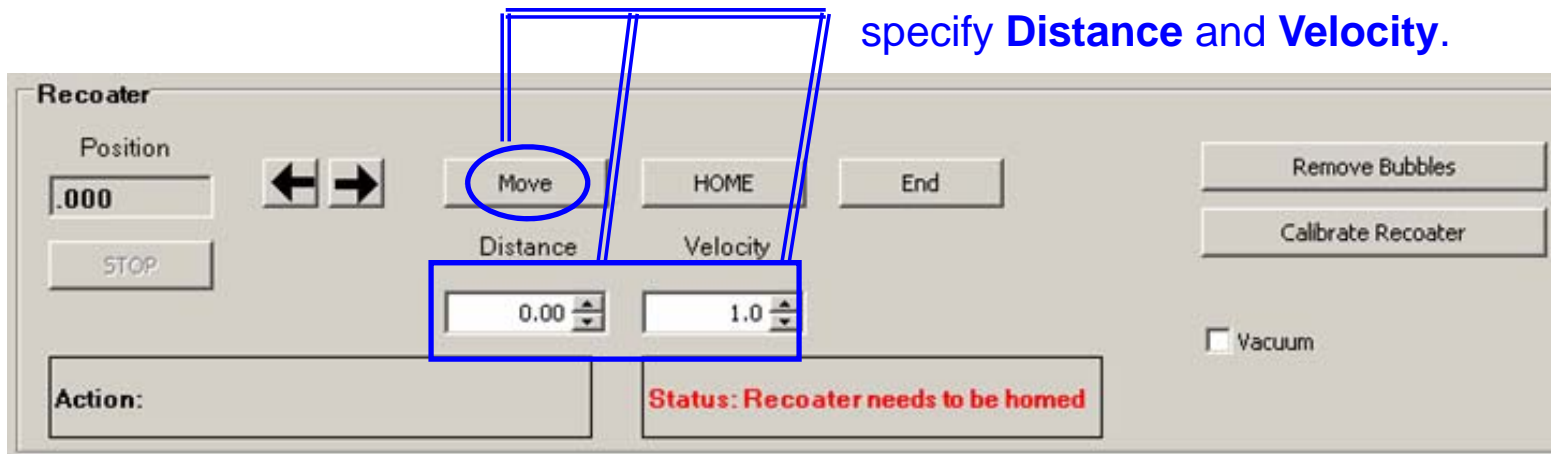

To **Move** the Recoater forward or back, specify **Distance** and **Velocity**.



Position: Shows the current position of the elevator relative to the home position

The following buttons perform the actions to alter the position.

Stop: Stops all motion during the move.

FORWARD/BACK: Moves the Recoater forward/back by placing the cursor  over the intended direction and pressing and holding the left mouse button  until the intended recoater placement is achieved, or until the recoater reaches a direction limit.

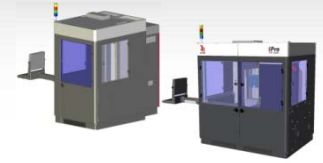

Move	HOME	End
Distance	Velocity	
0.00	1.0	

Move: *Manually* moves recoater as the user specifies.

Distance: Specifies distance, in inches or millimeters, from current position; negative moves recoater toward the front of the machine, positive moves recoater toward the rear of the machine.

Home: Moves the recoater motion axes to their home positions and redefines the home position (relative zero position of the recoater).

Velocity: Specifies the recoater speed, in inches or millimeters per second, during manual motion; it does not affect motion during the move.

End: Moves the recoater to its rear limit.



Note: These values apply only to manual movement.

Remove Bubbles
Calibrate Recoater
<input type="checkbox"/> Vacuum

Remove Bubbles: Runs a pre-defined operation to remove bubbles on the resin surface.

Calibrate Recoater: Runs a pre-defined operation to calibrate the recoater system.

Vacuum: Check Box that allows the user to turn on/off the ZephyrTM recoater's vacuum.

Action:	Status: Recoater needs to be homed
---------	------------------------------------

Action: Describes the current recoater action.

Status: Displays if the recoater has been reset by sending it to its *Home* location.

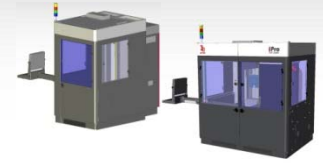

Leveler

The manual **Leveler** controls the resin level in the RDM through the use of the gross fill and leveling pumps on the front of the RDM. It also allows for the resin to recirculate.

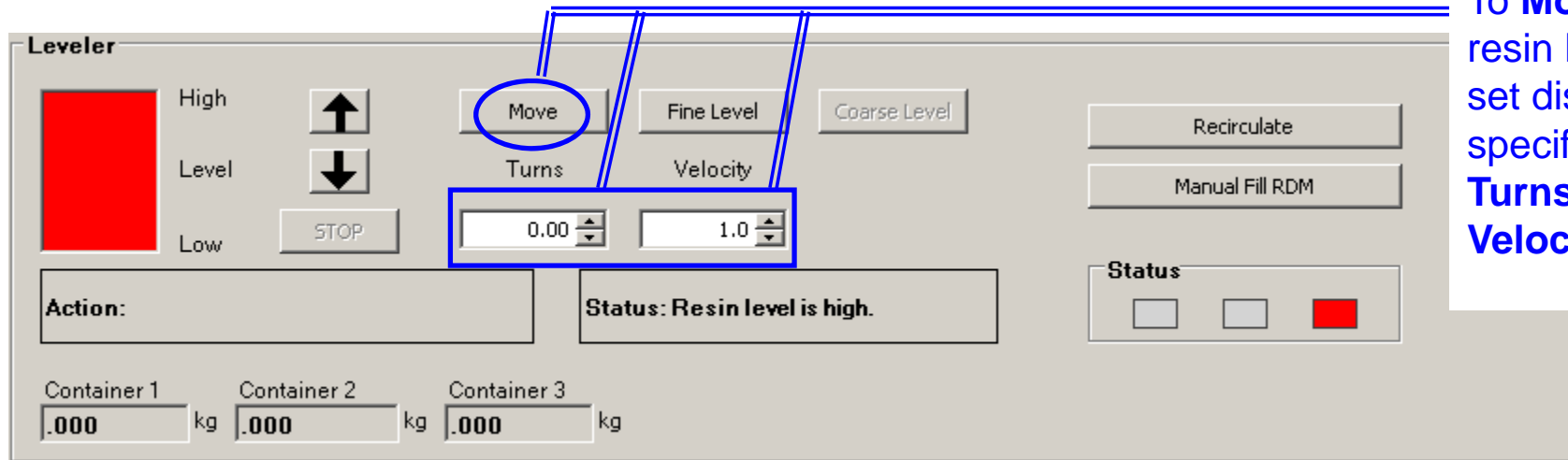

To **Move** the resin level by a set distance, specify the **Turns** and **Velocity**.

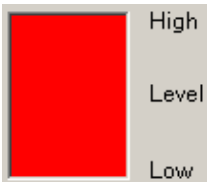

Coarse Level: Monitors the leveling container status and refills the RDM if resin is low.

Note: If the course level has not been performed first, the leveling bottle can overflow or continue pumping when empty.

Move: Manually controls the leveling pump (**Turns** unit = pump revolutions).

Fine Level: Adjusts the resin level to the build start height by using only the leveling bottle and pump.

Recirculate: When machine is idle, recirculate resin in the RDM; clicking **Recirculate** starts resin recirculation and changes the button to **Stop Recirculate**.

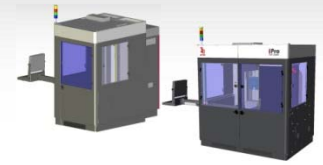

Clicking **Stop Recirculate** stops the recirculation.



Turns: Defines the amount of resin to be pumped; negative pumps resin into the RDM from the leveling container; positive pumps resin out of the RDM into the leveling container.

Velocity: Specifies the pump speed in revolutions per second.

 **Note: For most resins, 1.5 is the optimal speed.**

Manual Fill RDM: This function opens another window. This allows the user to pump resin from the refill containers into the RDM. To accomplish this, place the cursor  over the **Fill** button and press the left mouse button  until the intended RDM resin level is achieved. If the RDM is overfilled, manual removal is required.

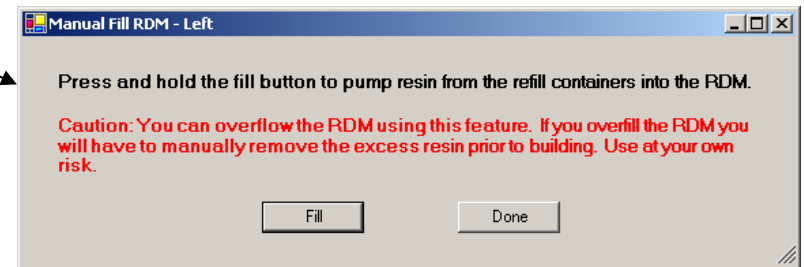



In some instances, such as after a high volume build, the resin may be lower than the machine can detect. This function is good for adding resin back to a level that the machine can detect, and then allow the machine to level properly.



Read all warning messages.

Action: Describes the current recoater action.

Status: Displays if the recoater has been reset by sending it to its *Home* location.

 **UP/DOWN:** Adjusts the resin level in the RDM by pumping resin into and out of the leveling container. To accomplish this, place the cursor  over the intended direction. Press and hold the left mouse button  until the desired level is achieved.

 **Note: If the course level has not been performed first, the leveling bottle can overflow or continue pumping when empty.**



Status Indicator: Notifies user if the machine leveling systems are in range and functioning correctly. **Green** – All good **Yellow** – Do a systems check

Red – Manual intervention required (system will not course level).

 **Note: These indicators apply to all course resin fill systems.**

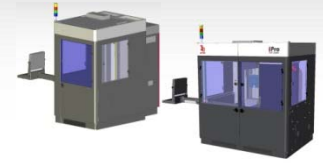

Scanner

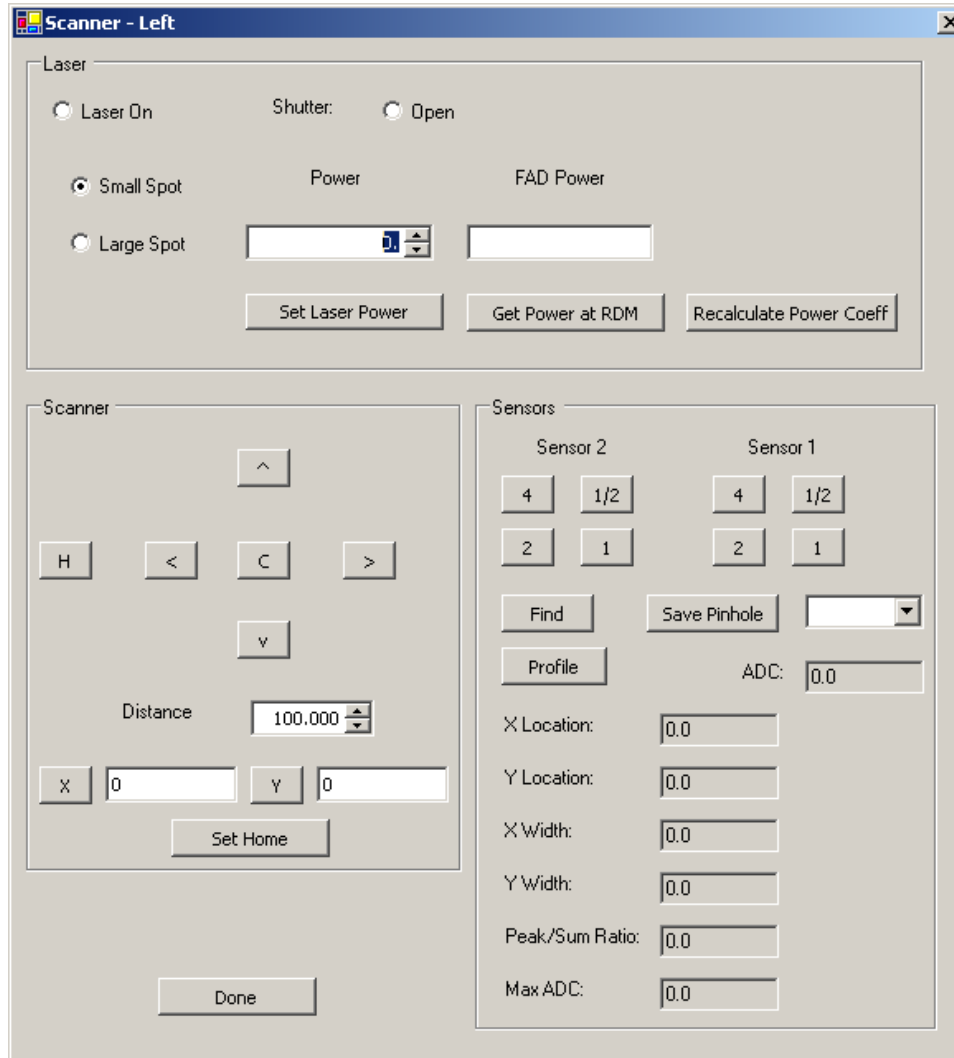

Scanner, explained in more detail on the following pages, enables the user to make manual adjustments regarding the Laser, Scanner, and Sensors.

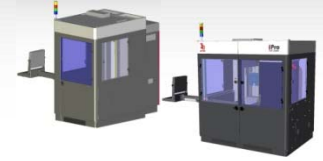

Laser

Laser

Laser On Shutter: Open

Small Spot Power FAD Power

Large Spot

Laser On: Toggles the laser on or off, by either check (on) or uncheck (off).

Shutter: Toggles safety shutter open or closed, by either check (open) or uncheck (closed).

Small Spot: Sets IPM to the small spot focus position.

Large Spot: Sets IPM to the large spot focus position.

Set Laser Power: Sets Laser Power (in milliwatts mW) to the value that is in the power field, if achievable.

Get Power at RDM: Directs beam to the Full Area Detector (FAD) and determines the power, in milliwatts, as measured by the FAD.

Recalculate Power Coeff: Adjusts the power calibration for the decline of laser power over time. This option is available here, but is not necessary for the user to perform. This function is accomplished each time the laser power is set.

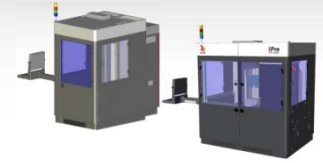

Scanner

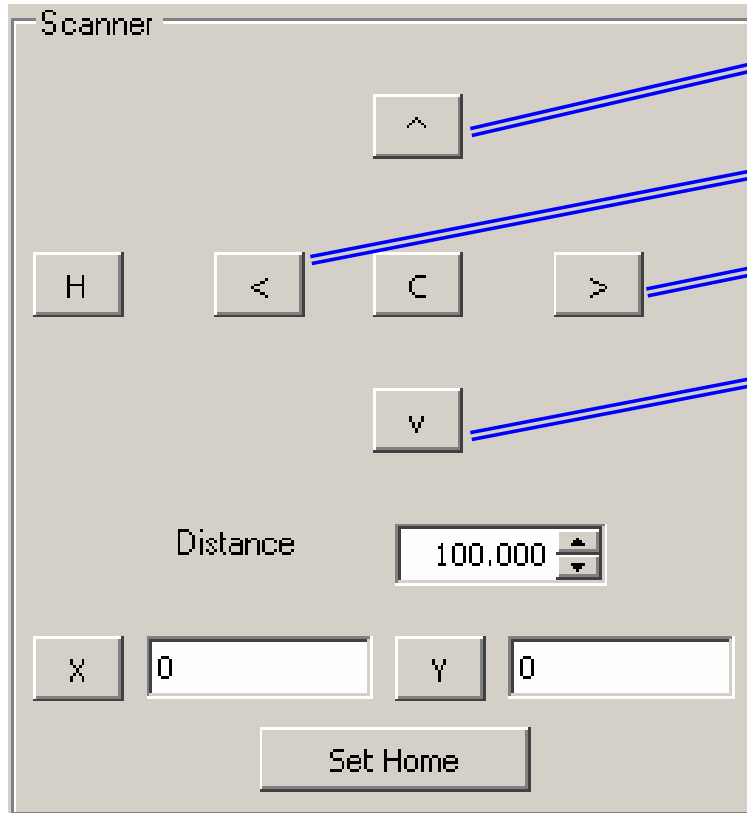

Moves beam in the positive Y direction

Moves beam in the negative X direction

Moves beam in the positive X direction

Moves beam in the negative Y direction

H: Moves the beam to the home (rest) position.

C: Moves the beam to the center of the build chamber.

X: Shows current X coordinate of the beam.

Y: Shows current Y coordinate of the beam.

Set Home: Selects current X and Y coordinates as home position.

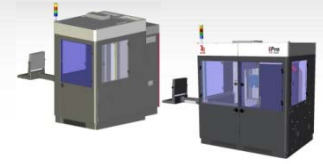

Distance: Defines the distance increment when moving the beam with the arrow buttons. To move the beam faster, use a larger value; for finer movement, use a smaller value.



Note: Moving the beam to reach the scanner limit will result in a fatal error. This will require the system to be restarted.



Note: When using the arrows to move the scanners, it can position the beam within the build chamber area causing resin to cure. If left long enough, there is a potential for the resin to burn.

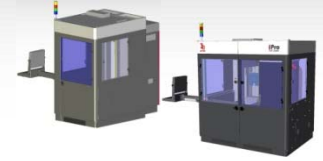

Sensors

Sensors

Sensor 2		Sensor 1	
4	1/2	4	1/2
2	1	2	1
Find	Save Pinhole	[Dropdown]	
Profile	ADC:	0.0	
X Location:	0.0		
Y Location:	0.0		
X Width:	0.0		
Y Width:	0.0		
Peak/Sum Ratio:	0.0		
Max ADC:	0.0		

Sensor 1:

Sensor 1 settings are the same as sensor 2.



Note: Sensor 1 is not used in a single or dual RDM hardware configuration, therefore, the default values may not be defined. Sensor 2 is utilized for all hardware configurations.

Sensor 2:

1/2: Moves beam to 1/2 mil pin hole on Sensor 2 (1 mil = 0.001 in.)

1: Moves beam to 1 mil pin hole on Sensor 2

2: Moves beam to 2 mil pin hole on Sensor 2

4: Moves beam to 4 mil pin hole on Sensor 2

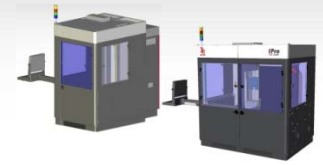

Find: Searches for a pin hole, starting at the current beam position.

Profile: Acquires and displays the power distribution and properties of the beam.

ADC: Shows the current intensity of the beam.

X Location: Shows the X coordinate of the beam.

Y Location: Shows the Y coordinate of the beam.

X Width: Shows the beam width, in mils, in the X direction.

Y Width: Shows the beam width, in mils, in the Y direction.

Peak/Sum Ratio: Indicates how well the beam is focused; the higher the value, the better the focus.

Max ADC: Shows the maximum intensity of the beam.

Save Pinhole: Saves the X and Y locations as the pre-defined location of the pin hole that is indicated in the list box to the right. You can change the pin hole using the dropdown window.



Note: If viewing the sensor window from the right side of a dual RDM (B side), the sensor 1 and sensor 2 locations will be exchanged.

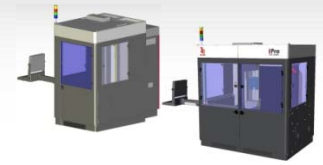

History

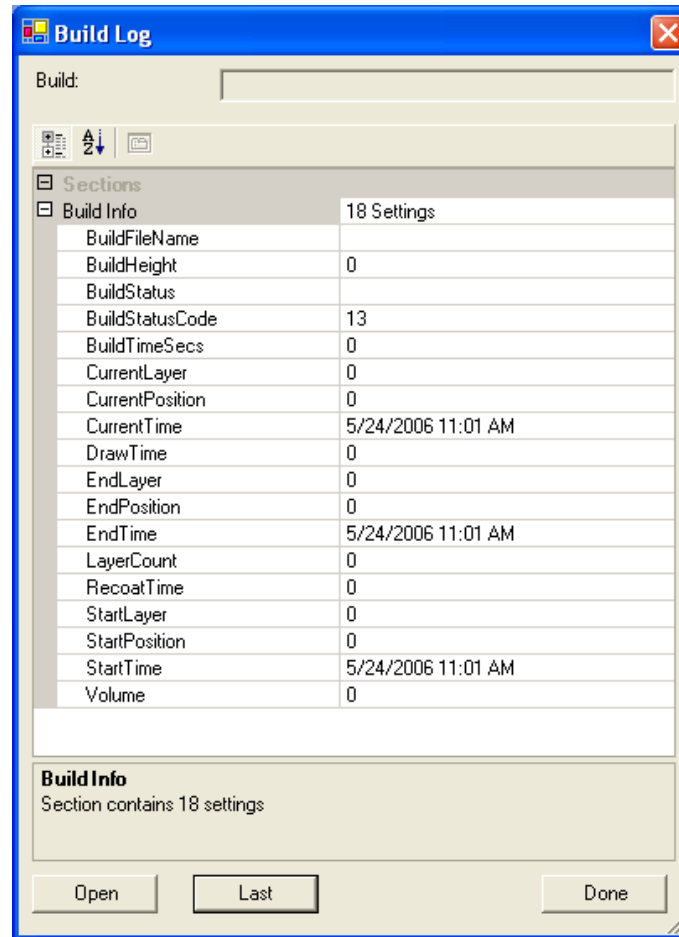

Build Log Window

History displays information about previous builds. Clicking on **History** brings up the Build Log window, which contains the information about the last build. If build is in progress, **Open** and **Last** are disabled.

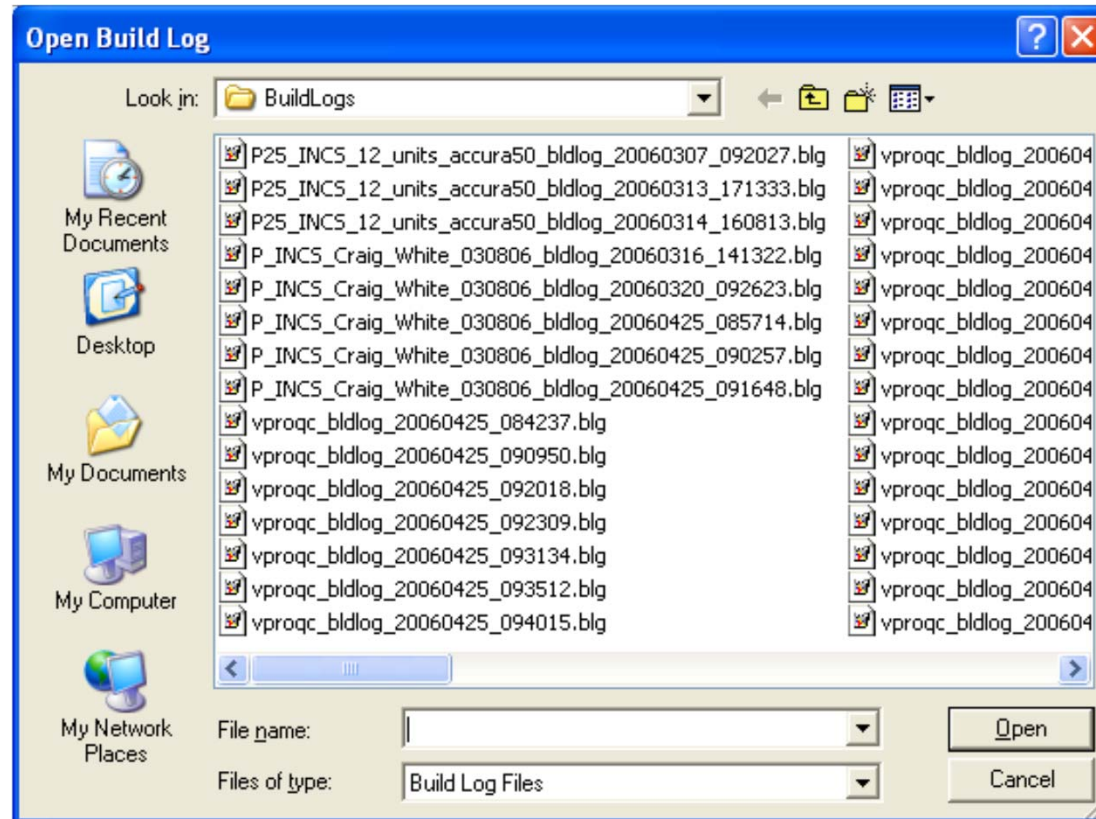
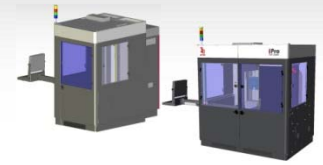

Open Build Log Window

Clicking **Open** displays the list of all previous builds. Selecting a file, or build, displays the information on that particular build.

Clicking **Last** displays the information of the last build.

Clicking **Done** closes the Build Log window.

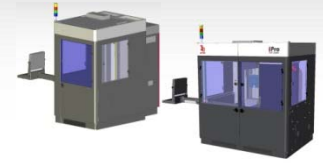

Machine Window

Status

Machine	
Resin:	Unknown
RDM Size:	No RDM Installed
Temp:	0°C A 0.0°C
Level:	Unknown
Power:	0 mW
Laser :	Off
LW Hrs:	0.00
Shutter :	Closed
<input type="checkbox"/> Door Interlock <input type="checkbox"/> ByPassKey Enable	
Status Settings Options Scale	

Status enables you to display the properties of the resin delivery module (RDM), as well as the available laser power.

Resin: Displays the resin name.

RDM Size: Displays the build capacity of the RDM.

Temp: Displays the current RDM temperature.

A: Displays the current air temperature.

Level: Shows the current resin level.

Power: Shows the maximum available laser power.

Laser: Displays if the laser is on or off.

LW Hrs: Displays the number of warranty hours the laser has run.

Shutter: Displays status of the laser safety shutter (open/closed).



Note: These windows are not updated during a build. If the laser is turned on or the shutter is opened by the build process, the status shown may be incorrect.

Door Interlock: Displays if all door interlocks are closed.

ByPassKey Enable: Displays if the interlock bypass key is active.

[Software Overview](#)

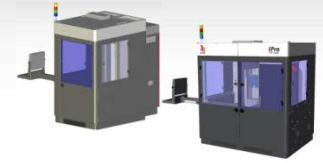

Settings

Machine

Name

Air Temp °C

RDM Temp °C

Alarm Temp °C

Laser Max mW

Geo File

Laser Off Timer Mins

PHD Distance mm

Status
Settings
Options
Scale

Settings enables you to view/change the machine settings.

Name: Displays the resin.

Air Temp: Selects air temperature in degrees C.

RDM Temp: Selects the resin temperature in degrees C.

Alarm Temp: Selects the temperature at which the RDM heater shuts off to prevent overheating.

Laser Max: Allows the user to slow the system down by lowering the maximum power level to be used by the system.

Geo File: Displays the current IPM calibration file.

Laser Off Timer: Allows the user to set the laser to power off after a set number of minutes and the completion of a build.

 **Note: For dual RDM or XL configurations, only the left side (A side) valve will be used.**

PHD Distance: Allows the user to specify the smallest vector length to enable PHD.

 **Note: Default and recommended setting is 0.**
PHD = Post Hatch Delay

 **Note: If no RDM is installed, values will be undefined.**

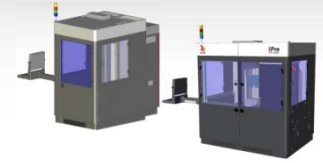

Options

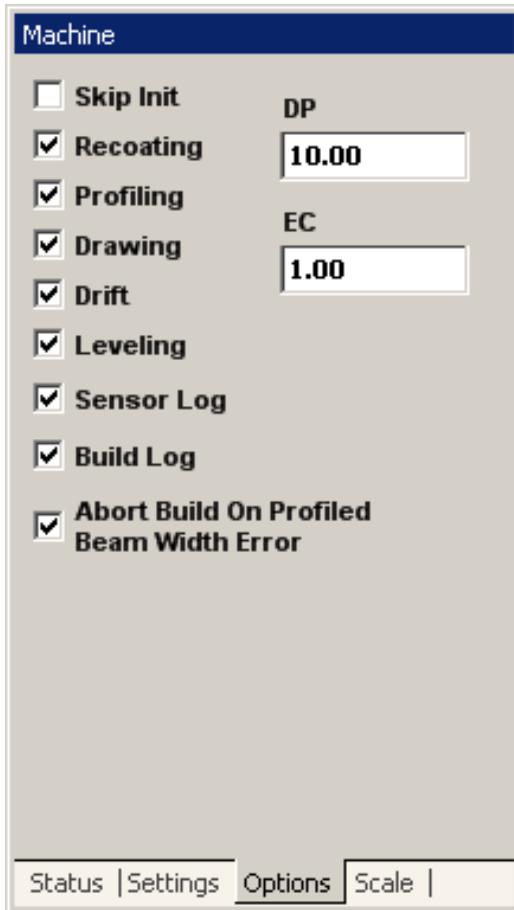

Options enables you to select or deselect the machine options for the build. *Checking* the boxes selects the following options:

Skip Init: Skips the initial operations of the build, including coarse resin leveling and proper elevator positioning.

Recoating: Recoats during the build.

Profiling: Profiles beam and determines drawing speed during the build.

Drawing: Draws, or solidifies, the polymer to create the part during the build.

Drift: Performs the drift correction during the Drawing (see previous entry).

Leveling: Checks and resets, if necessary, the resin level to the appropriate build level.

Sensor Log: Writes the sensor information into a file.

Build Log: Writes the build information into a file.

Abort Build On Profiled Beam Width Error: Allows the build to abort if the beam width measurement is not within system specifications.

DP: Enables you to display and to change the current value of the resin's penetration depth.

EC: Enables you to display and to change the current value of the resin's critical exposure.

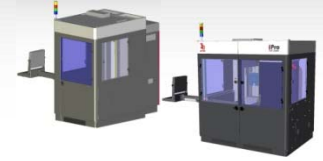

Scale

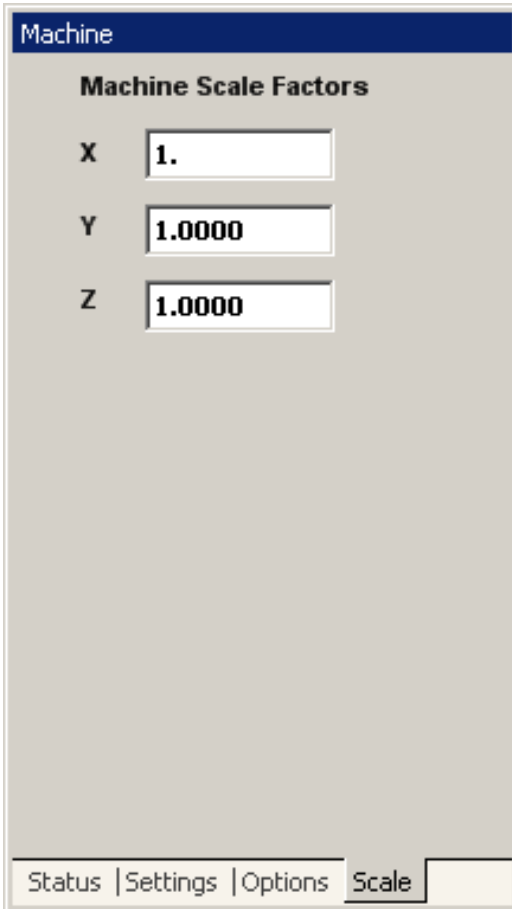

Scale enables you to set the X, Y, and Z scale factors of your build. The default value for these settings is 1.0000.

- X:** Sets the X coordinate
- Y:** Sets the Y coordinate
- Z:** Sets the Z coordinate



Note: *Build Scale Factors* and *Machine Scale Factors* are added together to achieve the final build scale.

Example:

<i>Build Scale</i>	+	<i>Machine Scale</i>	=	Build Result
x = 1.001		x = 1.001		x = 1.002
y = 1.001		y = 1.001		y = 1.002
z = 1.000		z = 1.001		z = 1.000

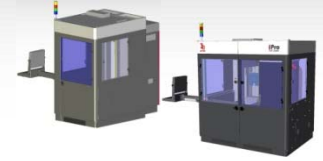

Build Window Status

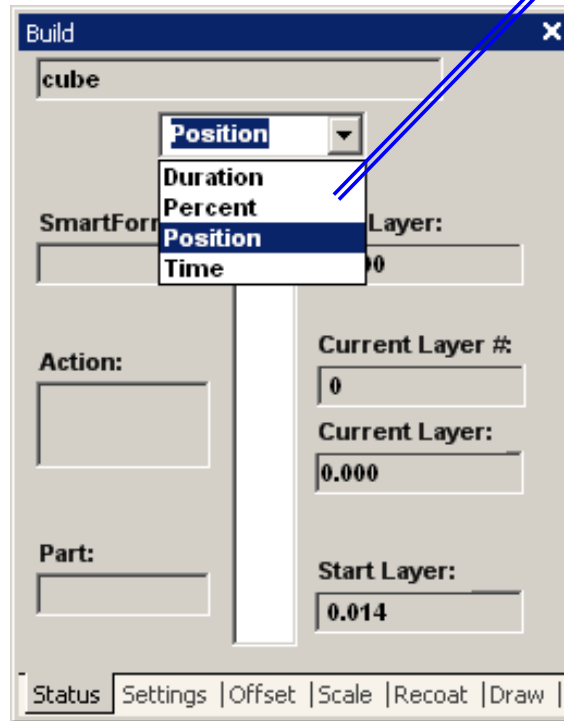

Build Status Dropdown

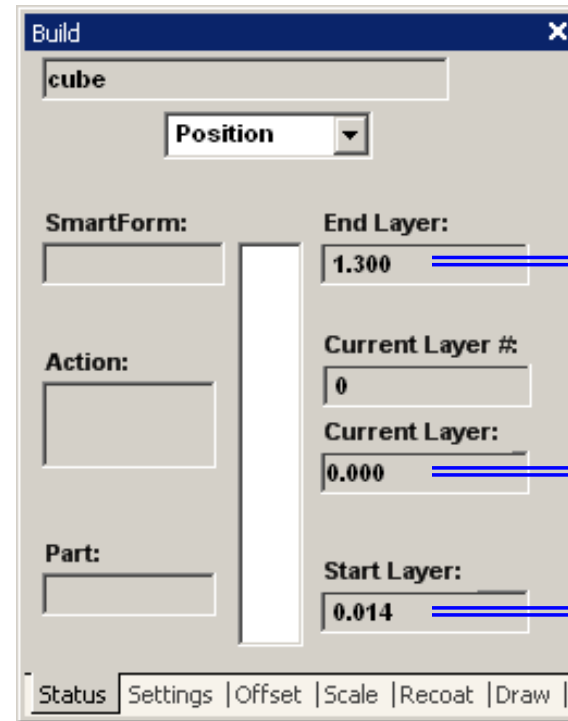

End Build Value

Current Status

Start Build Value

Status shows specific information on the build, as it progresses. The End of Build, Current Build, and Start of Build fields show data at various stages of the build.

Build Name: Shows the name of the build file (e.g. "cube").

SmartForm: Displays the **SmartForm** used to create the build.

Action: Shows the current operation of the build in progress.

[Software Overview](#)

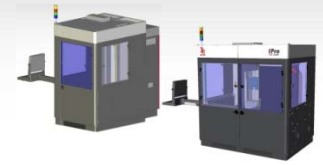

The **Build Status** dropdown enables you to change the units of the status of the build.

--- units can be in inches for Position.

--- percentage for Percent

--- hours, minutes, and seconds for Duration and Time (clock).

Position: Shows the position of the build status depending on original CAD Z coordinate. The units, inches or millimeters, will be consistent with the units used in the build file.

Percent: With 0% as the start and 100% as the end, shows the percentage completed of the current build.

Duration: With 0:00 as the start and the projected time of completion as the end, shows the time that has elapsed at the current build.

Time: In real time, this clock shows the time that the build started, the current time, and the projected time at the end of the build.

 **Note:** The format of the values in the right hand column will change depending on the dropdown selected.

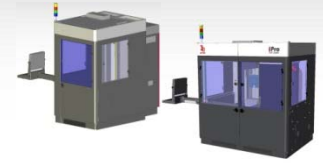

Settings

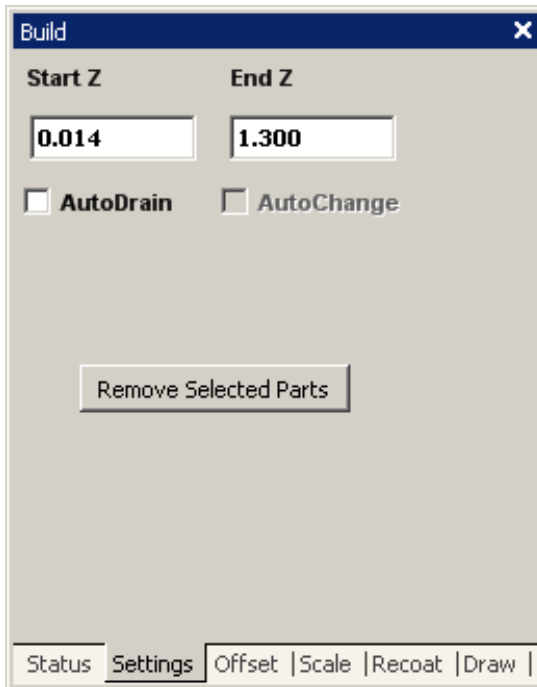

Start Z: Enables the user to choose the Z location of the build file, where the build will start; if the Start Z value entered is *less than* the minimum Z extent, the build starts at the minimum; if the Start Z value entered is *greater than* the maximum Z extent, the build will not start.

End Z: Enables the user to choose the Z location of the build file, where the build will end; if the End Z value entered is *less than* the minimum Z extent, the build will not start.

AutoDrain: Checking this box causes the elevator to move the part to the drain position, which is out of the resin when the build is complete; when the box is unchecked, the part stays where it is, submerged in resin, when the build is complete.

Remove Selected Parts: Enables the user to remove specific parts from a build.



Note: Refer to the [Parts List](#) for information on selecting part(s).

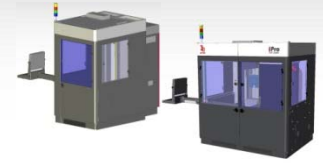

Offset

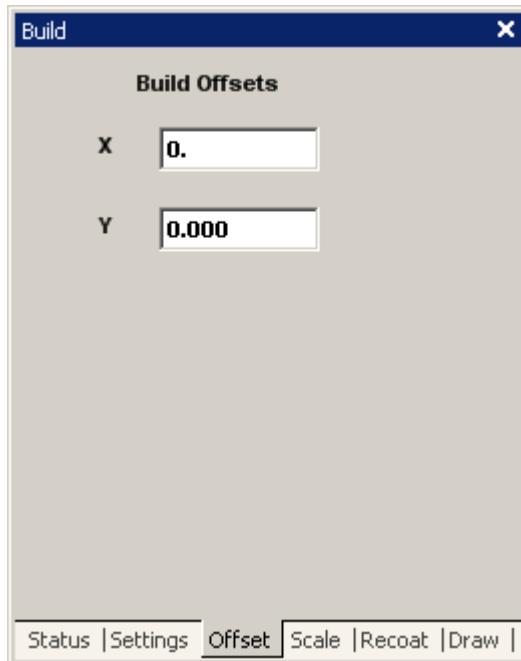

Build **Offset** enables you to shift the location, in the X and Y direction, of the build on the platform. This is used to center the calibration on the platform.



NOTE: If used to position the build, the SmartSweep parameters do not get updated, and the build is likely to fail.

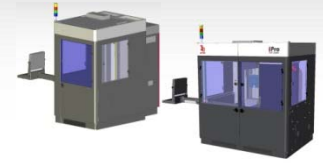

Scale

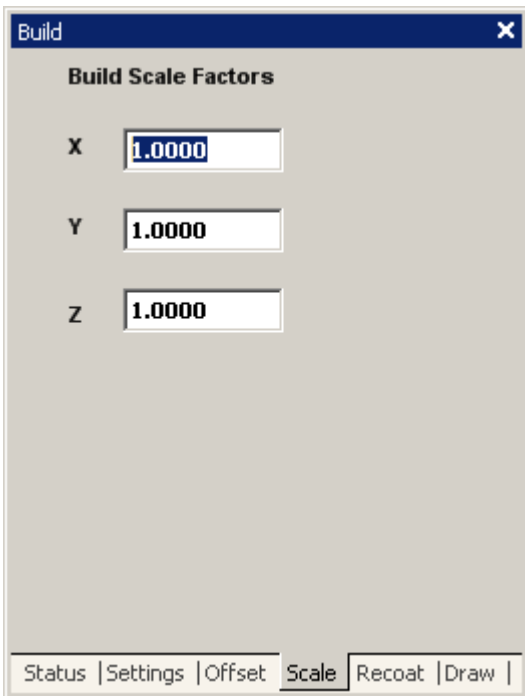

Build **Scale** enables you to scale the current build in the X, Y, and Z direction.



Note: *Build Scale Factors* and *Machine Scale Factors* are added together to achieve the final build scale.

Example:

<i>Build Scale</i>	+	<i>Machine Scale</i>	=	Build Result
x = 1.001		x = 1.001		x = 1.002
y = 1.001		y = 1.001		y = 1.002
z = 1.000		z = 1.001		z = 1.000

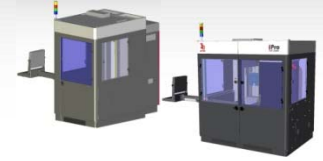

Recoat

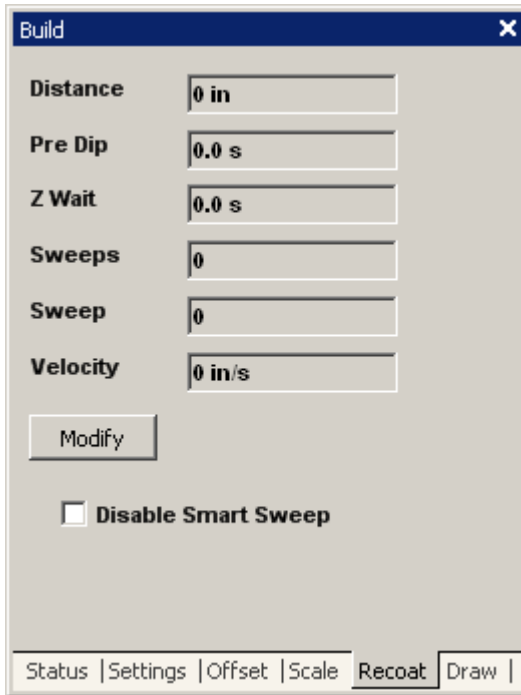

Build **Recoat** displays the recoat parameter values as defined when the build file was created by the 3DManage™ Software.

Distance: Displays elevator dip distance in units (inch/mm) defined by the .bff file.

Pre Dip: Displays the time delay in seconds between the elevator dip and the leveling operations.

Z Wait: Displays the time delay in seconds between the recoating and the drawing operations.

Sweeps: Displays the number of recoater blade sweeps *per layer* during the recoating process.

Sweep: Displays the percent blade gap.

Velocity: Displays the velocity of the sweeping motion in units (inch/mm) defined by the .bff file.

Disable Smart Sweep: Checking this box forces the recoat sweeping distance to the maximum stroke of the blade for every layer during the build.

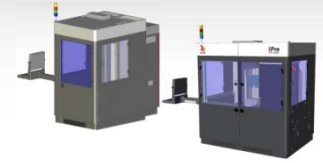

Modify: This function opens another window.

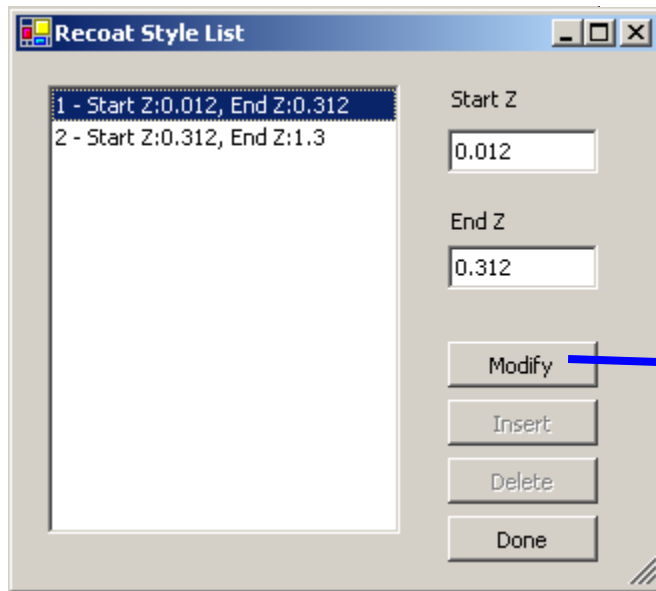

This allows the user to select a recoating range and **modify** the values.

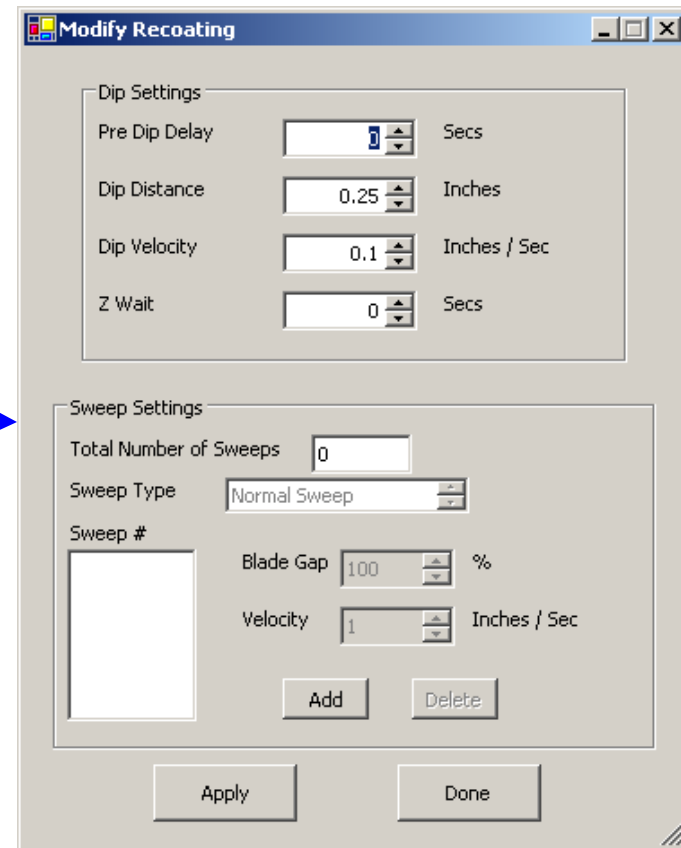

 **Note:** To change this parameter during the build: stop the build, update the setting, and restart the build.

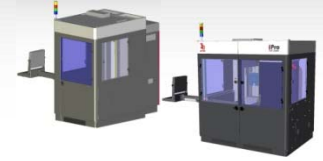

Draw

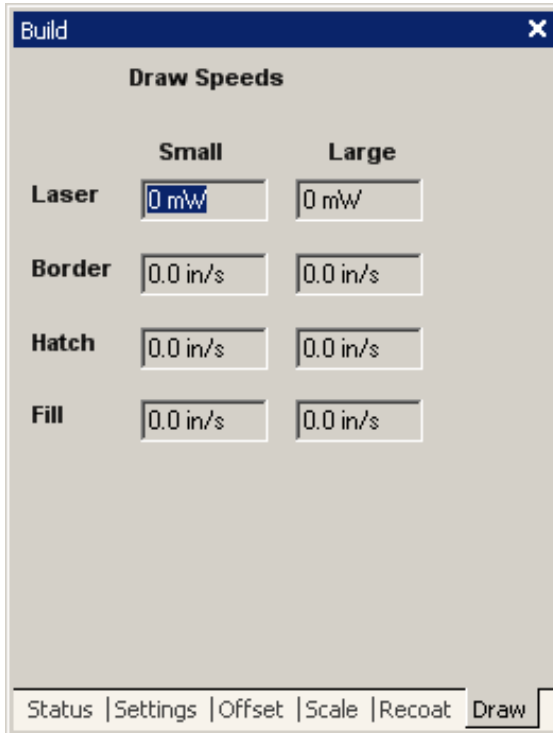

Build Draw displays the most recent, or current, values for laser power and vector drawing speeds.

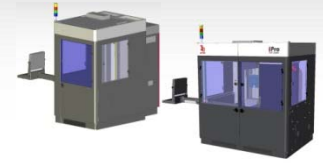

Parts List Window

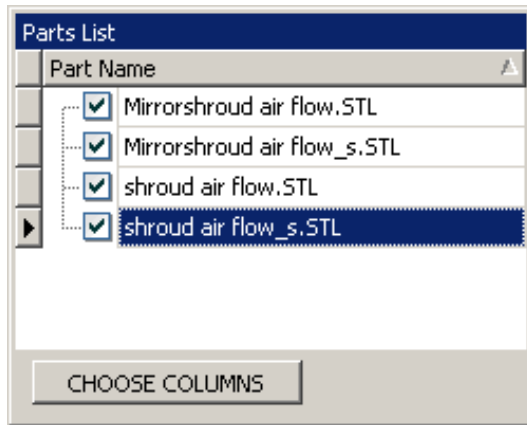

The **Check box** marked with a check indicates that the part listed is *visible* to the user.

← The **Highlighted** Part Name indicates the part is *selected*.

The **Parts List** gives the contents of the build file. Clicking on the **CHOOSE COLUMNS** button opens the **Customization** window to show the X, Y, Z extents and the volume of each stereolithography part.

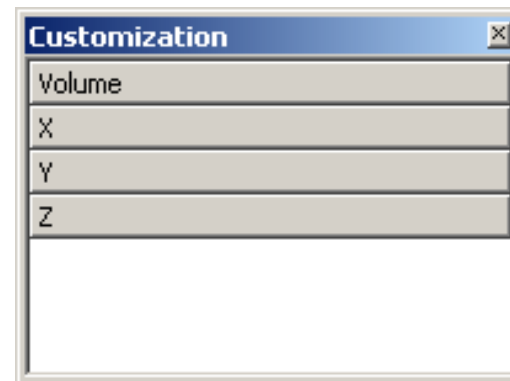

[Software Overview](#)

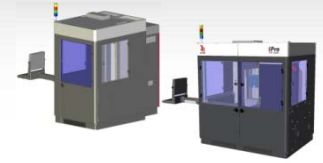

Mechanical Process

Blade Installation and Removal

Recoater Blades

The recoater blade is on a rail system above the resin delivery module (RDM). The recoating process combines elevator and recoater blade movements to apply liquid resin to the top of the part so that the next layer can be built. The blade, which contacts the liquid resin, can be removed from the iPro 8000/9000 SLA Center. The blade should be kept with the RDM so that when the resin is changed, the blade remains with the resin that it has been in contact with.



Note: Recoater blade tabs are delicate. Extra care should be taken to prevent damage to them. If tabs are damaged, the calibrate recoater process will not function properly, resulting in build failures.

To install the recoater blade, follow these steps:

1. Take the blade off the blade rest that is on the RDM.
2. Place the blade onto the two locating pins.
3. Secure blade with thumb screws.

To remove the recoater blade, follow these steps:

1. Loosen thumb screws.
2. Remove blade from the two locating pins.
3. Place blade onto the blade rest that is on the RDM.



Note: During the build operation, if the build completes or stops, or if the recoater stalls, the recoater automatically moves back to the home position.

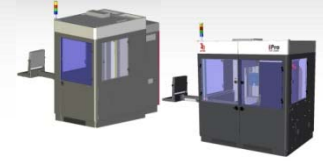

Platform Installation

The RDM must be in the machine before this process starts. When correctly installed, the platform sits on the elevator platform mount.

1. Make sure that the elevator motion stage is at its offload position.
2. Place the platform on two **L-shaped guides** in the rear of the RDM.
3. Push the platform against the **front platform guides**.
4. Make sure that the **notches** in the platform engage into the front platform guides.
5. Go to the Control Panel, select a part, and start a build.
6. When correctly installed and started, the elevator main stage moves to the Build Start position.

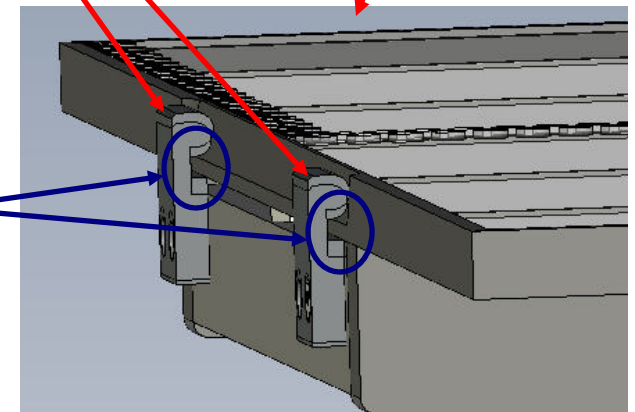
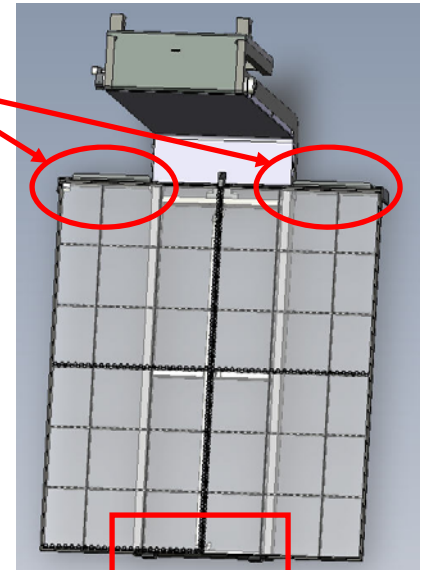

Note: The manual operation is an alternate method to move the platform to the build start position. With this, the user can also remove bubbles prior to starting a new build.

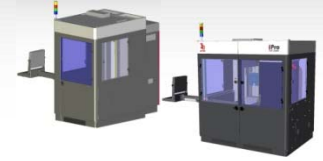

Platform Release

After the build is complete, select **Drain Platform**. This function raises the elevator motion stage to the top and the locking mechanism disengages. You can then reach in, move the platform backward, release the locking tab, and then slide the platform back and remove it.

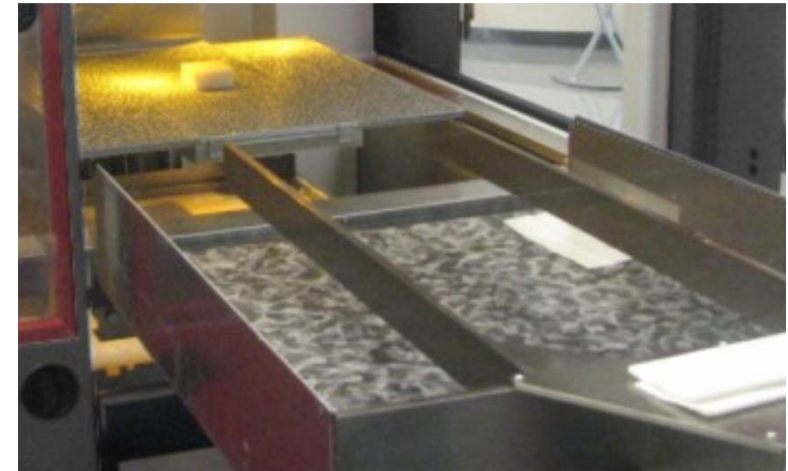
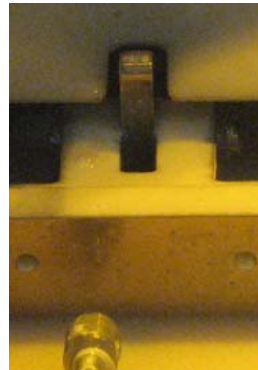

Refill Containers

The refill containers, in the middle and left receptacle, are connected to the refill pump. Each bottle moves resin from the refill container into the RDM. See [Resin Delivery Module \(RDM\)](#).



Note: Do NOT remove or replace the leveling container.

Leveling Containers

The leveling container, in the right receptacle, is connected to the leveling pump. This bottle is used for fine leveling. The resin is moved into and out of this bottle, so do not remove or replace this bottle. See [Resin Delivery Module \(RDM\)](#).

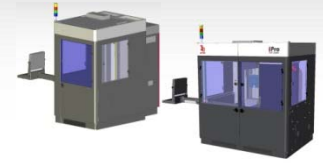

Resin Delivery Module (RDM) Installation

Make sure that the elevator is at its lower limit and that the recoater module is in the rest position. Assuming the RDM is outside the iPro 8000/9000 SLA Center, the following steps describe how to install it.



Note: Before installing the module, note that the RDM is very heavy and may require more than one person to remove or install it.



Caution: Irritant

While wearing protective clothing, disposable nitrile gloves, and goggles, follow these steps:

1. Open the RDM door; roll the RDM to the side of the machine in which you want to place it.
2. Make sure that the connecting cables are out of the way of the RDM before you attempt to place the RDM in the machine.
3. Make sure that the elevator is at its lowest position before you move the RDM into the machine.
4. With a cleared path, push in the RDM until the **locking pin** located on the outer side of the machine pushes up and then goes into place in the hole. When the locking pin (see following photo) attaches properly, the RDM will also hit the bumper at the back of the machine.



Locking Pin



Note: Move the RDM very slowly. Sudden starts and stops can result in resin spills, even with the RDM lid in place. Continuous slow movement is important.

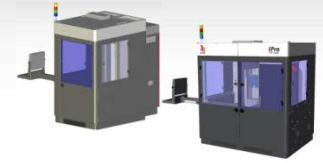

5. Once the RDM is in the machine, connect the cables. There is a black power cord and a gray cable bundle. Plug the three-pronged black power cord into the IEC receptacle on the RDM and place the connector into the keys. Note that the keys must be aligned when installing the connector. When properly placed, the key on the RDM umbilical cord receptacle lines up with the keyway on the I/O Connector.



RDM Umbilical Cord Receptacle

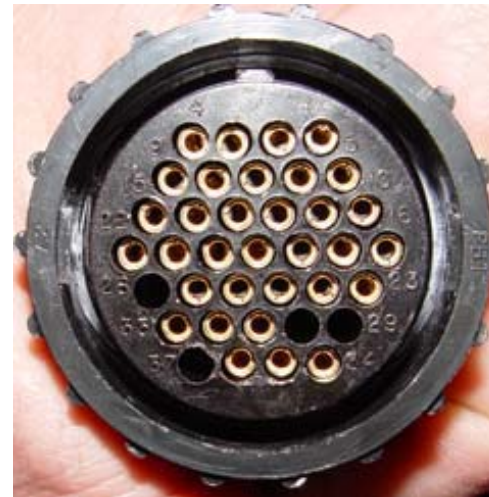

I/O Connector

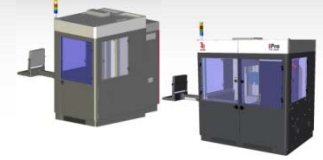

6. Plug in the power cord and turn on the switch.



RDM Heater Power Switch

7. Close the RDM door.

 **Note: See the following page for the additional step necessary for the RDM650.**

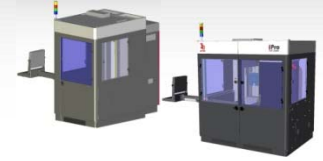

To use the RDM650, the iPro™ machine must have the rotary switch shown below installed. Some iPro™ machines upgraded from Viper Pro™ may not have the limit sensor switch. Please verify that this switch is on your machine before using the RDM650.

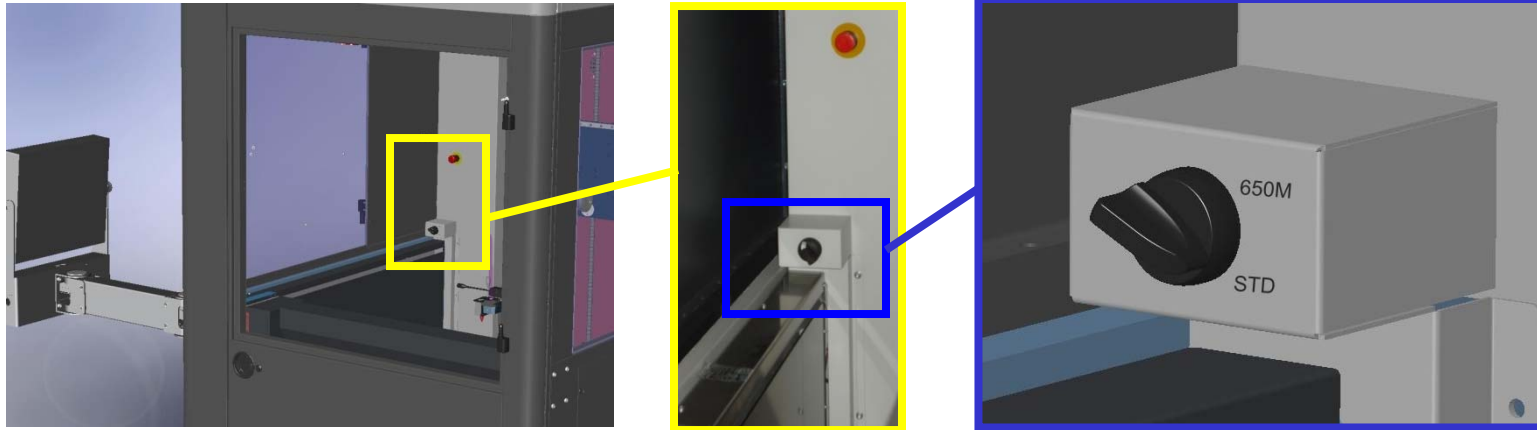

When an RDM 650 is detected, a message is displayed with the following instructions:

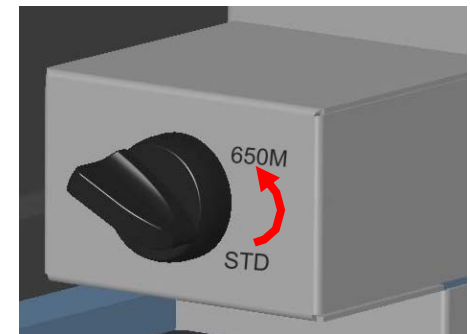

For all other RDMs, the switch must be set back to the "STD" position.



Note: If the switch needed, but not present...

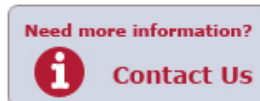

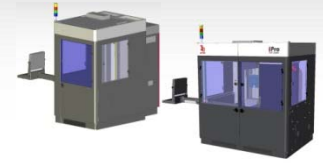

RDM Removal

The RDM is made of stainless steel and has casters for moving and maneuvering it while installing or removing it from the frame. There are also handles on the RDM that help to transport and maneuver it into and out of the iPro 8000/9000 SLA Center.

1. Open the RDM door.
2. Exit the 3DPrint software (this will ensure the valve position on the RDM is properly closed for removal).
3. Turn off the switch and disconnect the power cord. (See "[RDM Heater Power Switch](#)")
4. Disconnect the cables. There is a black power cord and a gray cable bundle. Unplug the three pronged black power cord from the IEC receptacle on the RDM and take the connector out of the keys. (See "[RDM Umbilical Cord Receptacle](#)" and "[I/O Connector](#)".)
5. Disconnect the locking pin, located on the outer side of the machine. (See "[Locking Pin](#)")
6. Make sure that the elevator is at its lowest position before you move the RDM out of the machine.
7. Make sure that the connecting cables are out of the way of the RDM before you take the RDM out of the machine.
8. Place the RDM lid into position.
9. Take the RDM out of the machine and close the RDM door.



Recirculation

During periods of non-operation, the RDM can recirculate resin to improve resin uniformity and life. For more information, see "[Recirculate](#)".

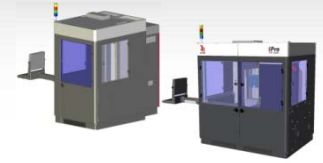

Resin Delivery Module Temperature Control

The iPro 8000/9000 SLA Center offers offline and online heating. When the power cord from the machine is connected, the system has online heating; when the power from a wall outlet is connected, the system has offline heating. The RDM can be heated either outside the iPro 8000/9000 SLA Center's enclosure, via the stand-by mode, or in the enclosure. Resin can be heated from a room temperature of 20 0C to 28 0C, or as needed. Typical time for heating is two to three hours, but cold resin can take considerably longer.

Auto Resin Refill System

The auto resin refill system is located on the RDM. This system adds resin to the RDM from the resin container(s) placed within the refill slots (slot 1 and 2). If the resin level is too low, the auto resin refill system will display the message, "Resin Autofill in Progress," and will add resin from one of the containers. The build starts after resin is at the correct build level. If the resin refill containers are empty, the system will alert the user to replace them with full containers.

Resin Container Removal

When the resin container is empty and needs additional resin, or if a partially full container needs to be replaced with a full container, perform the following procedure. It is important to verify the type of resin currently in the RDM before proceeding with these steps. While wearing protective clothing, disposable nitrile gloves, and goggles, perform the following steps:

1. Open the front machine door that corresponds to the resin's build zone.
2. Place the vent cap on the vent hole and screw tightly to prevent the resin from spilling.

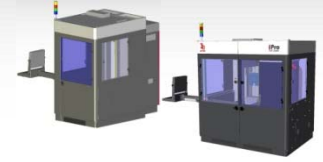

Release Lever



Release Lever

3. Pull the RDM release lever, located to the left of the resin bin toward you.

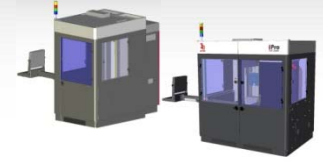

Container Release Button

4. Push the container release button, located on the lower right corner of the resin bin.



**Container
Release
Button**

5. Lift out the resin container.

6. Using a disposable paper towel, wipe all resin from the container seal assembly.

7. To remove the container, carefully lift it from the container slot and, if empty, dispose of the container according to local regulations.

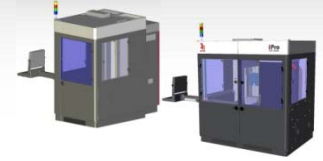

Resin Containers

Before adding a new container, make sure that the container slot is empty. If a container is present, refer to the previous section, "[Resin Container Removal](#)," before continuing.

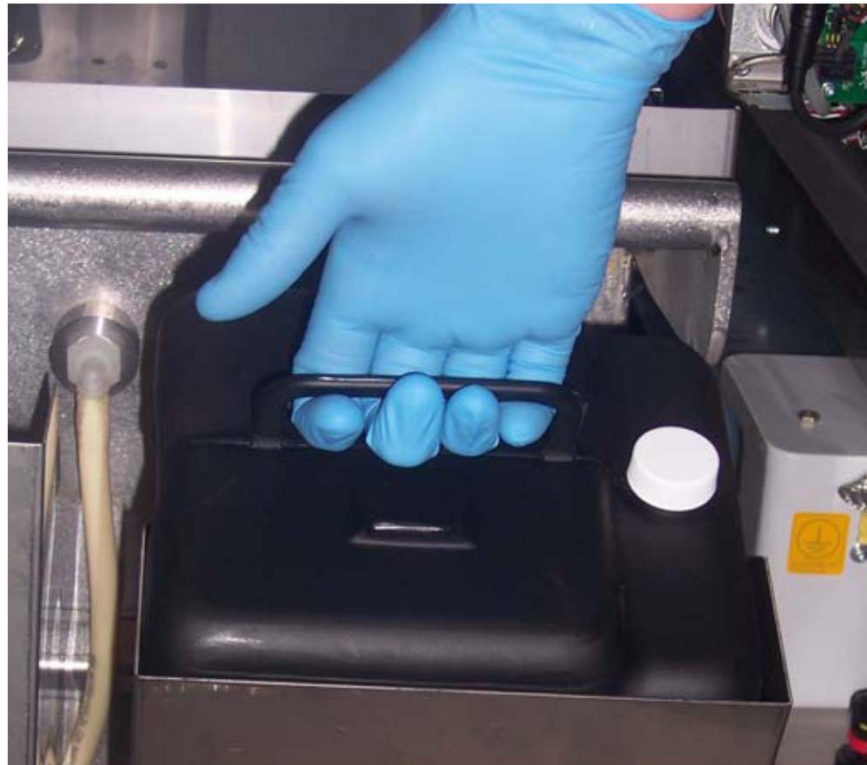

Container Lifted

While wearing protective clothing, disposable nitrile gloves, and goggles, perform the following steps:

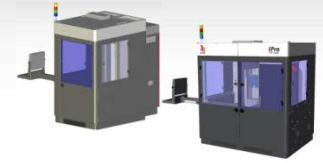

1. Open the RDM door.
2. Obtain the resin container that is compatible with the resin that is in the RDM.



Caution!

Make sure that you have selected the correct resin container. Selecting a container that is incompatible with the resin type in the RDM can damage the machine.

3. Remove the vent cap and puncture the small hole on the container.



Note: All containers have a depression in the areas to be punctured. Unless the vent has been previously punctured, and you are very certain of this, puncture the vent.

4. Pull the release lever of the slot in which you wish to install the container.
5. Insert the container into the supply container slot.
6. Look at the status on the user interface.
7. If the status is okay, push the container until the RFID cap is fully seated.
8. If the bottle is new, puncture the vent; otherwise go directly to Step 9.
9. Close the RDM door firmly, until it latches securely.
10. Close the resin container door firmly until it latches securely.

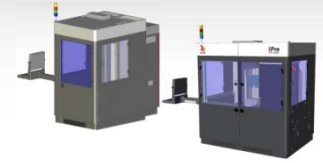

Troubleshooting

Power Outages

If you are present when a power outage occurs, or if you discover that the main power is off, complete the following steps:

1. Switch the power OFF at the iPro 8000/9000 SLA Center's electronic cabinet so that it does not automatically start when the power is restored; doing so prevents damage from power flickers and surges.
2. When the power is restored and stable, switch the iPro 8000/9000 SLA Center power ON at the cabinet.

iPro 8000/9000 SLA Center Shutdown

If you do not plan on operating the iPro 8000/9000 SLA Center on a regular basis and want to shut it down for an extended period of time, shut down Windows and turn off the main disconnect. See [“Electrical Cabinet: Closed Door”](#).



Note: It takes a substantial amount of time for the iPro 8000/9000 SLA Center to warm up after a full shutdown/power off. See [Resin Delivery Module Temperature Control](#).

Error Symptoms and Other Problems

[“Error Symptoms”](#) contain problems that can occur with your iPro 8000/9000 SLA Center. Please consult the table if you have any problems.

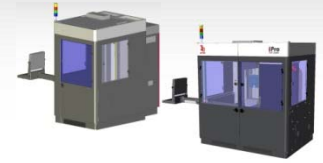

Table 3: Error Symptoms

SYMPTOM	CAUSE	ACTION
Controller does not operate.	<p>Breaker on DC power supply is tripped.</p> <p>Loose cables or poor connection exists at the plug.</p>	<p>Reset breaker.</p> <p>Check the plugs and cables to ensure that they are tightly connected and that the electrical outlet is working. Verify that the unit power switches are ON.</p> <p>Check the contrast and brightness on the monitor.</p>
Entire system does not power up.	<p>Emergency stop switch, chamber or control panels, are depressed.</p> <p>Main power plug is not engaged.</p> <p>No power is coming from the wall.</p> <p>The iPro 8000/9000 SLA Center circuit breaker is tripped.</p>	<p>Reset switch and power up system.</p> <p>Plug cord into the wall outlet.</p> <p>Reset circuit breaker for the wall outlet.</p> <p>Reset circuit breaker.</p>

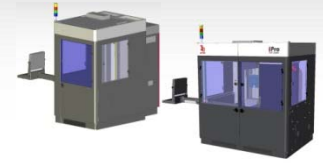
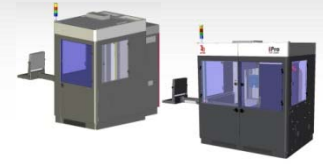

Table 3: Error Symptoms (continued)

SYMPTOM	CAUSE	ACTION
<p>The laser does not operate.</p>	<p>The laser is not turned on. Laser interlock not satisfied. 3D equipment interlock safety rely not satisfied.</p>	<p>Turn the power supply key to the ON position. Verify that the switch on the laser power supply is ON. Turn on the laser. Read error shown on laser power supply. See Customer Support Hotline on page 99. Satisfy all safety interlocks or the laser will not operate. If interlocks cannot be satisfied, see Customer Support Hotline on page 99.</p>
<p>Elevator, leveler, or sweeper does not move.</p>	<p>Loose cables. Door or resin delivery module panel interlock not engaged. Blown fuse Bad circuit board or motor driver.</p>	<p>Secure all connections. Check that the door/resin delivery module panel interlocks are operating. See Customer Support Hotline on page 99. Try to move using the 3DPrint toolbar. Reboot. See Customer Support Hotline on page 99.</p>



Customer Support

If you receive an unrecoverable error message, or if you need to contact us for another problem, you may contact our Customer Support Hotline. Before you call Customer Support with a problem or question, please make sure that you have the following information:

- The serial number of the iPro 8000/9000 SLA Center (located on the rear panel)
- A brief description of the problem, including the exact error message
- When the problem occurred; for example, when you submitted a job, during the beginning or the end of a build, or after power off recovery

Customer Support Hotline

Please contact your Customer Support Hotline at one of the following numbers:

- In North America, call 1-800-793-3669
- In Asia and the Pacific Rim, call +852 2923 5077
- In Germany, call +49-6151-357 357
- In the United Kingdom, call +44 1442 282665
- In France, call (+33) 01 60 87 88 77
- In Italy, call +49 (0) 6151 357 357
- In Switzerland, call +41-26-439 95 90
- In Japan, call (+81) 3 5451 1690

 **Want to know more?**
Click here for more info!

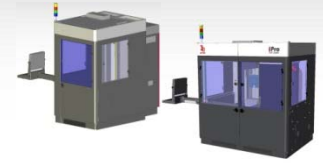

Service

General

SLA Center service procedures must be performed only by a 3D Systems-certified service technician unless this guide explicitly states otherwise.

If your SLA Center needs service, contact 3D Systems Technical Support at the following numbers:

- In the United States or Canada, call 800-793-3669
- In Europe, call +49-6151-357357

You can also contact your local 3D Systems representative. For material safety data sheets and other technical support information, go to this 3D Systems' Web site address:

<http://www.3dsystems.com/techsupport/index.asp>

Laser



UV Radiation

SLA Center laser service procedures must be performed only by 3D Systems certified service technicians. Attempts by non-certified personnel to perform laser service procedures can result in serious eye damage. All SLA Center users must observe the guidelines and warnings in "[Laser Safety](#)".

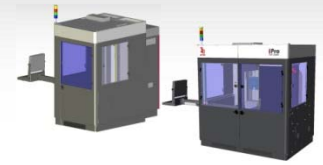

The SLA Center conforms to applicable requirements of 21 CFR Subchapter J at the date of manufacture. It is designated a Class I Laser Device by the Center for Devices and Radiological Health (CDRH). In normal operation, the laser beam is completely confined and the viewing windows in the Process Module block the UV laser radiation. However, if the laser cover, doors, or windows, are removed for any reason, the unit becomes a dangerous Class IV laser device. Direct or reflected laser power from a Class IV laser device can cause eye damage. See [Laser Safety](#) for more information.

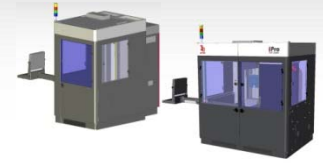

Maintenance



Damage

If the equipment is used in a manner not specified by the manufacturer, the protection provided by the equipment may be impaired.

iPro 8000/9000 SLA Center Cleaning and Decontamination

Clean the iPro 8000/9000's inner and outer surfaces and windows periodically as described in the following paragraphs.

iPro 8000/9000 SLA Center Surfaces

Clean the iPro 8000/9000 SLA Center's outer surfaces as needed following the following guidelines.

Dust Removal

Remove dust from the outer surfaces of the iPro 8000/9000 SLA Center by wiping with a clean, dry, lint-free cloth.



Damage

Do not remove any outer panels when cleaning the iPro 8000/9000 SLA Center. Panels must be removed only by a qualified 3D Systems Customer Support Representative.

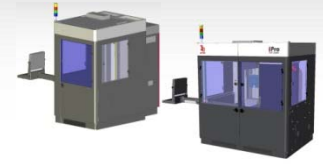

Preventive Maintenance

Your iPro 8000/9000 SLA Center must have preventive maintenance (PM) performed by a qualified 3D Systems Customer Support Representative. Contact 3D Systems after one year of build time.

Gel Filtering

Resin life is adversely affected by partially-polymerized material in the RDM, both in debris, such as broken supports and crash remains, and in gel. In order to maintain the longest possible resin life, the user should remove as much debris as possible, either continuously or periodically. Gel should be kept apart from neighboring gel, to avoid viscosity increase. Gel continually forms, both in the bulk of the RDM, and around debris that has settled to the bottom of the RDM. Gel may cluster into larger masses, may gradually increase in molecular weight because of chain growth, and may or may not settle to the bottom of the RDM, depending on the specific resin and the state of the gel. Debris removal prevents some gel formation, although not all gel is related to larger debris. Gel can be very difficult to actually remove, as it isn't easily separated from viscous resin, is slippery, and can clog filters and sieves.

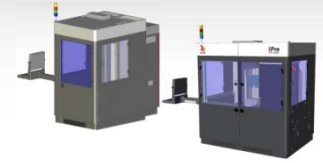

Damage

Do not leave debris in the machine and do not allow debris to bypass the debris-catching device.

Gel must be kept apart from its neighboring gel, which requires continuous resin movement in the RDM. When installed in the RDM, the resin should circulate when not building. When offline the material does not circulate, nor does it need to. Circulation while online allows the resin to take up oxygen from the RDM surface, improving resin life by keeping the RDM temperature uniform.

Debris Filtering

Debris is removed periodically, as a maintenance-like action. At least once per month, use the debris removal tray. This removal process may be repeated more than once each month, if the user desires. This process involves a tray that has two filters. As the tray is lifted, the fluid goes through the filter and the debris are removed.

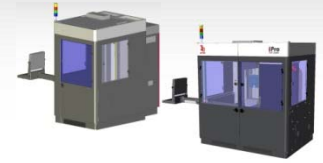

System Block Diagram (single build area)

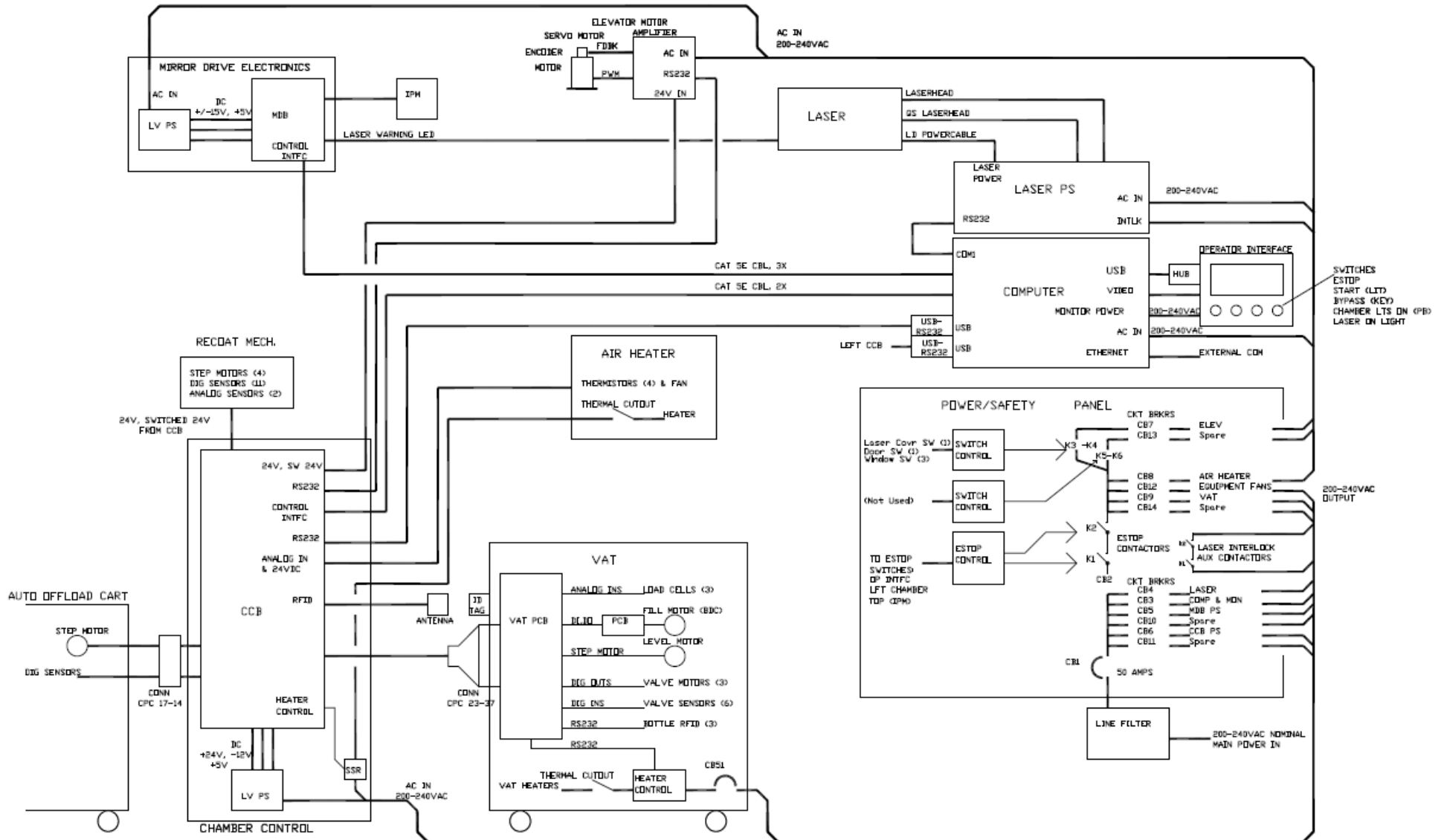

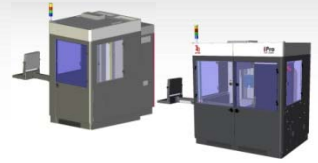

Electronic Chassis Diagram

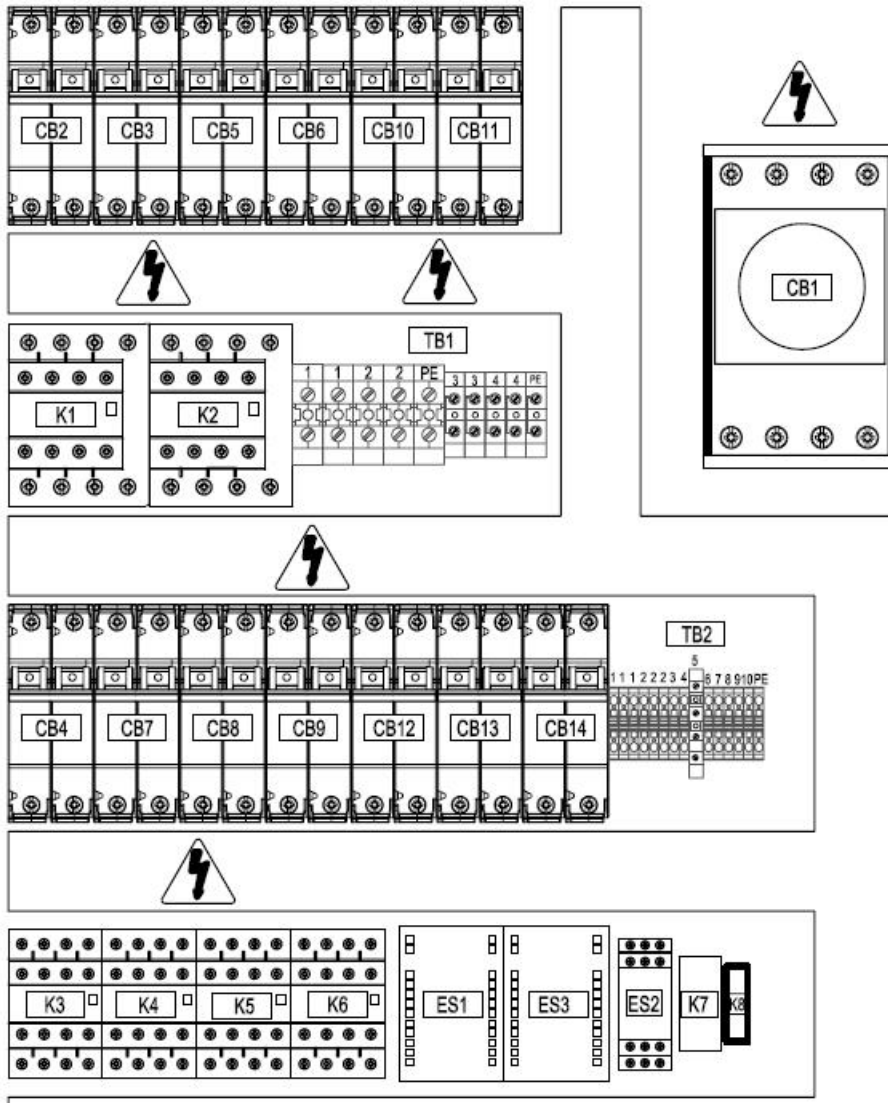

Component	Component Specification	Load Rating	Load
CB1	50A, 480Vac IC=35kA	46Amp	Main Power Circuit Breaker
CB2	30A, 277/480Vac IC=6kA	5600V	E-Stop Circuit loading
CB3	6A, 240Vac IC=10kA	200W	Computer Monitor
CB4	5A, 240Vac IC=10kA	750W	Laser Power
CB5	8A, 240Vac IC=10kA	1000W	Left Side CCB Power
CB6	6A, 240Vac IC=10kA	600W	Left Side MDB Power
CB7	15A, 240Vac IC=10kA	200W	Left Side Elevator
CB8	10A, 240Vac IC=10kA	1700W	Air Heaters
CB9	8A, 240Vac IC=10kA	1250W	Left Side Vat Heater
CB10	8A, 240Vac IC=10kA	1000W	Right Side CCB Power
CB11	6A, 240Vac IC=10kA	600W	Right Side MDB Power
CB12	10A, 240Vac IC=10kA	650W	Chiller/Equipment Fans
CB13	15A, 240Vac IC=10kA	200W	Right Side Elevator
CB14	8A, 240Vac IC=10kA	1250W	Right Side Vat Heater
K1	IEC Contactor 30A, 24V coil	5600V	E-Stop circuit
K2	IEC Contactor 30A, 24V coil	5600V	E-Stop circuit
K3	IEC Contactor 12A, 24V coil	200W	Door switch circuit:
K4	IEC Contactor 12A, 24V coil	200W	Door switch circuit:
K5	IEC Contactor 12A, 24V coil	200W	Door switch circuit:
K6	IEC Contactor 12A, 24V coil	200W	Door switch circuit:
K7	Relay 6A DPDT, 24V coil	1W	Door switch circuit:
K8	Relay 3A SPST, 24V coil	.5W	System Enable Circuit
TB1-1	Terminal block, UT16	N/A	Line
TB1-2	Terminal block, UT16	N/A	Line
GND	Ground terminal block, UT16	N/A	Ground
TB1-3	Terminal block, UT10	N/A	Line
TB1-4	Terminal block, UT10	N/A	Line
GND	Ground terminal block, UT10	N/A	Ground
TB2-1	Terminal block, ST2.5	N/A	24VDC
TB2-2	Terminal block, ST2.5	N/A	24RET
TB2-3	Terminal block, ST2.5	N/A	spare
TB2-4	Terminal block, ST2.5	N/A	Start
TB2-5	Terminal block, 3 level	N/A	Left-/U/I Estop OUT/Start light
TB2-6	Terminal block, ST2.5	N/A	Left-/U/I Estop IN
TB2-7	Terminal block, ST2.5	N/A	Right-Top Estop OUT
TB2-8	Terminal block, ST2.5	N/A	Right-Top Estop IN
TB2-9	Terminal block, ST2.5	N/A	Safety control 1 CUT
TB2-10	Terminal block, ST2.5	N/A	Safety Control 1 IN
TB2-11	Ground Terminal block, ST2.5	N/A	spare
ES1	Door Switch Controller	N/A	Laser and Left Side Switches
ES2	E-Stop control unit	N/A	Pilz Unit
ES3	Door Switch Controller	N/A	Right Side Switches

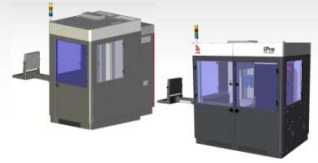

Legal Notices

Copyright and Corporate Identity

Copyright 3D Systems, Inc. All rights reserved. Subject to change without notice. This document is copyrighted and is the property of 3D Systems, Inc. The licensed user, in the name of whom this document is registered (the “Licensed User”) does not have the right to copy, reproduce, or translate this document in any way or to any media without the prior written consent of 3D Systems, Inc. No copies of the document may be sold or given to any person or other entity.

Improvements

3D Systems may (but shall not be obligated to) make improvements to this document from time to time. However, the Licensed User acknowledges that at any time after the expiration of the date of issuance, 3D Systems may institute a periodic charge or fee payable by the Licensed User in return for ongoing receipt of improvements. It is the responsibility of the Licensed User to provide 3D Systems with current information as to its name and address. The Licensed User also undertakes to notify 3D Systems promptly in the event that it considers any of the data contained in this document to be incomplete or erroneous in any respect, in connection with Licensed User's particular use or generally.

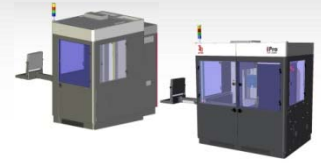

FCC Notice

This equipment has been tested and found to comply with the limits for a class A digital device, pursuant to Part 15 of the FCC Rules. These limits are designed to provide reasonable protection against harmful interference when the equipment is operated in a commercial environment. This equipment generates, uses, and can radiate radio frequency energy and, if not installed and used in accordance with the instruction manual, may cause harmful interference to radio communications. Operation of this equipment in a residential area is likely to cause harmful interference in which case, the user will be required to correct the interference at his own expense.

Changes or modifications not expressly approved by 3D Systems could void your authority to operate equipment.

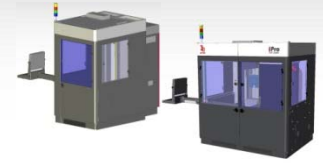

Radio Frequency Transmission

This product generates 13.56 MHz using an Inductive Loop System as a Radio Frequency Identification device (RFID). This RFID device complies with the requirements specified in FCC Part 15, Industry Canada RSS-210, European Council Directive 99/5/EC, and all applicable local laws and regulations.

Operation of this device is subject to the following two conditions: (1) this device may not cause harmful interference, and (2) this device must accept any interference received, including interference that may cause undesired operation.

The device referenced in this guide contains transmitter, FCC ID: 2ADGF-SKTKM1 IC: 12666A-SKTKM1

The device referenced in this guide contains transmitter, FCC ID: 2ADGF-CLDRIDQK IC: 12666A-CLDRIDQK

Access to the transmitter for service technicians is available through common enclosure access methods including use of common tools and removal of covers.

Note: Changes or modifications to this equipment not specifically approved by 3D Systems may void the user's authority to operate this equipment.

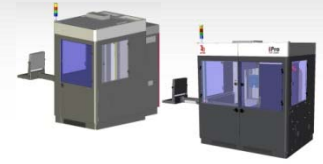

Glossary

3DManageTM File Preparation Software

Software used to verify STL files, orient parts, select build style parameters, generate supports, and create the files that are used for building on the SLA Center.

3Dverify software

A function in *3DManage File Preparation Software* that verifies and fixes STL files.

Acoustical Optical Modulator (AOM)

An electronic device which diffracts laser light to interrupt the laser beam as an on/off switch.

Analog-to-Digital Conversion (ADC)

Converts an analog signal to a digital signal.

Beam profile

A pattern of circles or numbers representing the spatial distribution of laser beam power. This power distribution automatically calculates drawing speeds to determine whether the laser should be adjusted or replaced, and to indicate whether the optics should be adjusted, replaced, or cleaned.

Beam profiler

A UV-sensitive detector over which the laser beam is moved to generate beam profiles. Two beam profilers are mounted in the process chamber.

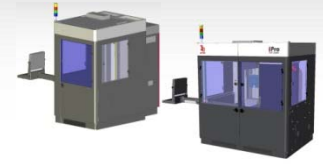

Border

A vector that defines the perimeter of a layer. Hatch and fill vectors are drawn between borders.

Build computer

See Control computer.

Build file(s)

The data file(s) produced by the *3DManageTM Software* and used by the controller to build parts.

3DPrint Control Software

Controller software which controls the building of stereolithography parts on an SLA Center.

Build style

A template file that defines slicing and part building parameters.

Bullet

The characteristic shape of the solid plastic created by a stationary laser beam on the surface of photocurable resin.

CAD

Computer Aided Design. The process of designing products by interaction with a computer rather than by the traditional method of hand drawing on paper.

CAD resolution

The internal approximation of surfaces within a CAD model.

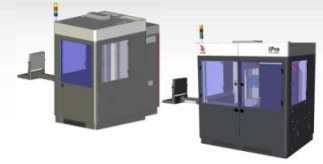

CAD units

Units of measurement used to construct the CAD model, such as millimeters or inches.

CAE

Computer Aided Engineering. The process of solving engineering problems by interaction with a computer. Computer Aided Design is a subset of CAE.

CAM

Computer Aided Manufacturing. Managing and directing manufacturing operations with the assistance of computers.

CDRH

Center for Devices and Radiological Health.

CFR

Code of Federal Regulations.

Chamber temperature

The controlled temperature in the process chamber.

Control computer

The controller mounted in the iPro 8000/9000 SLA Center cabinet that controls the building of stereolithographic parts.

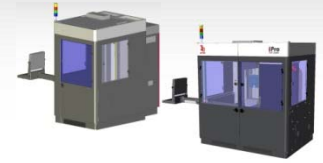

Controller

See Control computer.

Cure

The process of turning liquid resin into a solid by exposure to UV light.

Cure depth

The thickness or depth of a line of cured resin. The cure depth of any line is determined by the laser beam power and distribution, laser draw speed, and resin characteristics.

Curl

A characteristic type of part deformation.

Draining

Enabling resin to drip from the finished part into the RDM when the elevator is at its top position.

Drawing speed

The speed at which the laser traces over the surface of the resin to form solid plastic lines and surfaces. The laser drawing speed varies depending on the depth of solidification requested, laser beam power and distribution, and resin characteristics.

Dynamic mirrors

Motor driven scanning mirrors with encoder feedback that direct the laser beam to any point on the surface of the resin.

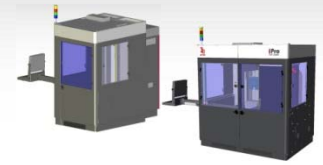

Elevator

The hardware components that raise and lower the platform and part in the vertical (Z) axis. Also called Z-stage.

Exposure

The total light energy absorbed by a point on the resin surface. Exposure increases with higher laser power and decreases with higher drawing speed.

Fill vectors (skin fill)

Overlapping parallel vectors that comprise the horizontal surfaces (skins) of stereolithographic parts.

Green part

A stereolithographic part prior to UV post-curing, but after laser curing in the resin delivery module.

Hatch

A vector that is drawn between layer borders and comprises the interior of the part.

Hatch spacing

A parameter that specifies the perpendicular distance between adjacent hatch vectors.

IPM (Image Projection Module)

Directs the laser beam using directional, focusing optics, and scanning mirrors, along with an AOM (Acoustical Optical Modulator) to regulate the output power. This process will accurately reproduce the input CAD data one layer at a time.

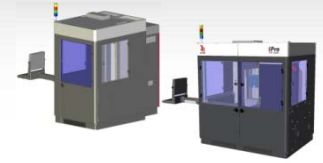

Laser

Light Amplification by Stimulated Emission of Radiation. The device that generates the light energy required to polymerize photocurable resin.

Layer

Thin horizontal section of laser solidified resin.

Layer thickness

The depth of a solidified layer of resin, as requested by the user.

Leveling

The process whereby the surface of the resin is adjusted to the correct distance from the dynamic mirrors.

Line

A line of cured plastic generated by overlapping bullets. See also vector.

Linewidth

The horizontal width of a laser cured resin line.

Monomer

A low molecular weight chemical species, which is a building block of polymers.

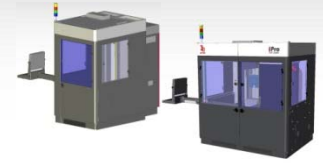

MSDS

Material Safety Data Sheet. Federal government mandated information about the chemical makeup of any chemical substance, such as resin. Usually includes identification of toxic substances and safe handling guidelines.

NIOSH

National Institute for Occupational Safety and Health.

Photoinitiator

A chemical in photopolymers that reacts with photons and catalyzes the polymerization process.

Photopolymer

A chemical substance composed of photoinitiators and monomers that polymerizes when exposed to light energy.

Photopolymerization

The process whereby light energy converts monomers into a polymer.

Platform

The perforated base on which parts are built by the SLA Center.

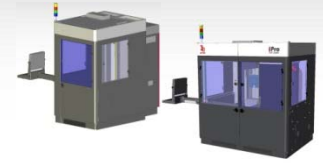

Platform locators

Features that secure and position the edges of the platform.

Platform supports

L-shaped brackets that support the platform and attach it to the elevator.

Polymer

A material built up from a series of smaller units (monomers). The molecular size of the polymer helps to determine the mechanical properties of the plastic material.

Polymerization

The process of linking small molecules (monomers) into larger molecules (polymers) comprised of many monomer units.

Post-Curing Apparatus (PCA) and ProCure equipment

A device which generates ultraviolet energy used to cure green stereolithographic parts.

Post-process

The process of cleaning, curing, and finishing stereolithographic parts.

Process chamber

The chamber in which the RDM, elevator, and beam profilers are located.

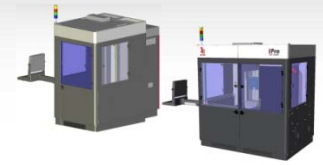

Recoating

The process of adding a layer of liquid resin with a user-specified thickness on top of the previously cured layer.

Recoat style

A style file that defines parameters associated with recoating during the stereolithographic process.

Recoater assembly

The assembly of an SLA Center that either applies resin to, or removes excess resin from, the part as the recoater blade moves across the RDM.

Recoater blade

The part of the recoater assembly that contacts the resin.

Resin

Another name for the photopolymer chemical used in stereolithography.

Resin Delivery Module (RDM)

The metal container inside the process chamber in the SLA Center that holds the resin in which the object is formed. On older SLA Centers, the RDM is referred to as the "Vat".

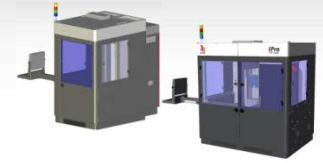

Safety shutter

A mechanical device that blocks the laser beam when an interlock switch is activated or when closed via the computer user interface.

Scan speed

See Draw speed.

Sensitization

An allergic response to a chemical stimulus, such as resin, generally resulting from repeated skin contact.

Skin (skin fill)

See Fill vectors.

SLA Center

See Stereolithography apparatus.

Stereolithography apparatus

The equipment used to produce stereolithographic parts.

Slice resolution

A slice parameter that specifies the number of slice units assigned to each CAD unit of measure.

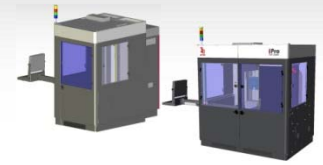

SmartSweep recoating process

A feature used to reduce the build times by sweeping only over that portion of the RDM where a part is being built instead of sweeping the full area of the resin delivery module. See Sweep.

Stereolithography

A three-dimensional imaging process that forms plastic objects by solidifying successive layers of photocurable resin.

Stereolithography file (STL)

The tessellated (triangulated) CAD input file.

Supports

Structures designed on the CAD system or by *3DManage File Preparation Software* to support a part above the elevator platform, provide a rigid foundation on which the object may be built, and attach and support layer sections.

Sweep

A pass of the recoater blade from the front of the resin delivery module to the rear or from rear to front. The act of removing excess resin from the upper surface of the part or adding a layer of fresh resin during the recoat process. See Recoating and also see SmartSweep recoating process.

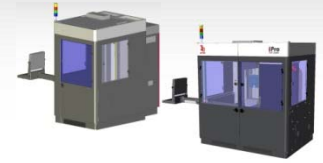

Tessellate

To represent CAD surfaces in polygonal format.

Trapped Volume

During building, a volume of resin within the part that cannot flow out to the surrounding liquid.

Triangle normal

A line perpendicular to a triangle starting at its center and pointing away from the mass of the part. Triangle normals are used to differentiate between inside and outside surfaces of a solid.

Ultraviolet (UV)

Electromagnetic radiation having a wavelength shorter than visible light, (i.e., below 390 nanometers).

Vat

On older SLA Centers, the metal container inside the process chamber in the SLA Center that holds the resin in which the object is formed. On the iPro 8000/9000 SLA Center, this container is called the RDM.

Vector

A directed line segment represented by starting and ending coordinates as defined in a stereolithography slice or build file.

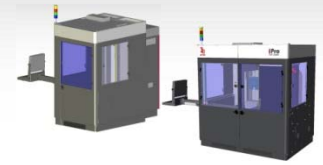

Workstation

The high powered personal computer with graphics capabilities, running the *3D Lightyear File Preparation Software* which creates the build files.

Zephyr™ Recoating System

A recoater blade system that uses an internal vacuum cavity to deposit resin on the part, improving trapped volume recoating effectiveness.

Z-Stage

See Elevator.

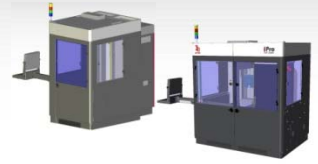

Specifications

Technical Data

For a complete **iPro**TM **SLA**[®] **Center** datasheet that includes *FEATURES*, *APPLICATIONS*, *BENEFITS*, and *TECHNICAL DATA*, refer to:

[SLA datasheets](#)

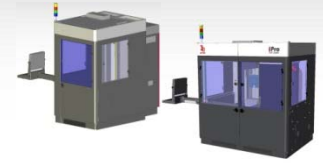

Index

A

[AC power](#)
[ADC](#)
[Altitude](#)
[AOM](#)

B

beam
[Intro](#)
[IPM](#)
[Safety](#)
[To FAD](#)
[Scanner](#)
[Sensor](#)
[Profile](#)
[Service](#)

build

[draw](#)
[envelope](#)
[history](#)

build (cont.)

[layer](#)
[object](#)
[plane](#)
[preview](#)
[recoat](#)
[status](#)
[volume](#)
[zone](#)

[build start position](#)
[build zone A](#)
[build zone B](#)
[build, view](#)

C

[changing resin](#)
[circuit breaker](#)
[circuit breaker Error](#)
[circuits](#)
[computer \(Controller\)](#)
cooling system
[laser](#)

D

[debris, straining](#)
[dip distance](#)
disconnect
[main power](#)
[RDM](#)
[Electric Cabinet](#)

drain

[platform](#)
[automatic](#)
[setting for automatic](#)

[dual resin delivery module](#)

E

[electrical cabinet](#)
[elevator start](#)
[elevator, manual](#)
[environmental conditions](#)
[extra large resin delivery module](#)

F

[FAD](#)
[power reading](#)

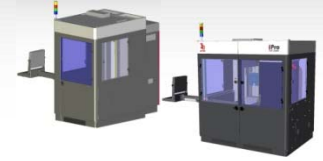

H

home button
[Elevator](#)
[Recoater](#)

[humidity](#)

I

[I/O connector](#)
[intelligent resin container](#)
[IPM](#)

K

[keyboard](#)

L

[large spot](#)
[laser](#)
[laser cooling system](#)
[laser on](#)
[laser power](#)
[laser power supply](#)
[layer, build](#)
[leveler](#)
[leveler, manual](#)
[leveling containers](#)

M

machine
[options](#)
[scale](#)
[settings](#)
[status](#)
[main power disconnect](#)
[manual](#)
[adjustments](#)
[elevator](#)
[leveler](#)
[operations](#)
[recoater](#)
[manual offload cart](#)
[maximum sweep distance](#)
[mode, stand-by](#)
[modify parameters](#)
[monitor](#)
[MSDSs](#)

O

[offline RDM warm-up](#)
[opening a file](#)

P

[parameters, modify](#)
[parts list](#)
[pausing a build](#)
[percent blade gap](#)
[plane, build](#)
[position](#)
[power distribution](#)
[preview, build](#)
pump
[circulation](#)
[gross fill](#)

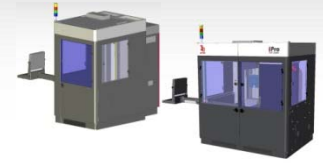

R

- [RDM removal](#)
- [recirculate](#)
- [recoater blade](#)
- [recoater blade sweeps](#)
- [recoater stall](#)
- [recoater, manual](#)
- [recoating module](#)
- [refill containers](#)
- [resin](#)
- [resin delivery module](#)
 - [dual](#)
 - [extra large](#)
 - [single](#)
 - [size](#)
 - [temperature](#)
- [resin level](#)
- [resin viscosity](#)
- [resin, changing](#)
- [rotate view port](#)

S

- [safety shutter](#)
- scanner
 - [buttons](#)
 - [operations](#)
 - [toolbar](#)
 - [window](#)
- [scanning system](#)
- [sensors](#)
- [single resin delivery module](#)
- [small spot](#)
- [stall, recoater](#)
- start
 - [elevator](#)
- [starting a build](#)
- [stopping a build](#)
- [straining debris](#)
- [sweep distance](#)
- [sweep velocity](#)
- [system requirements](#)
- [system secure](#)
- [system status lights](#)

T

- [temperature](#)
- [toolbar](#)
- [tools, for changing resin](#)

U

- [user interface](#)

V

- [vat](#)
- view
 - [port](#)
- view port
 - [rotate](#)
 - [zoom](#)
- [view, orthographic](#)
- [view, perspective](#)
- [viewing the build](#)
- [viscosity, resin](#)
- [volume, build](#)

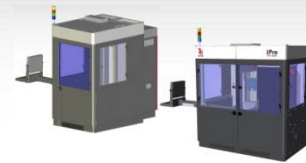

Z

[Zephyr recoater blade](#)

[zoom view port](#)

[zoom, in or out](#)